

TX-28/25LD20F Service Manual

Specifications

Parts List

Safety

Block
Diagrams

Service
Information

Schematic
Diagrams

Exploded
View

PCB
Views

Service Support

Service and repair of this product is supported by Panasonic's LUCI interface.

This interface provides a link between the TV and a standard PC to allow a number of diagnostic and control functions to be performed.

For more details contact your local Panasonic company.

BACK

EXIT

Service Manual



Colour Television TX-28LD20F TX-25LD20F EURO-4H Chassis

SPECIFICATIONS

(Information in brackets { } refer to TX-25LD20F)

Power Source:	220-240V a.c., 50Hz
Power Consumption:	121W
Standby Power Consumption:	1,4W
Aerial Impedance:	75Ω unbalanced, Coaxial Type
Receiving System:	PAL-B/G, H, I, D/K, PAL-525/60 SECAM B/G, D/K, L/L' M.NTSC NTSC (AV only)

Receiving Channels:

VHF E2-E12	VHF H1-H2 (ITALY)
VHF A-H (ITALY)	VHF R1-R2
VHF R3-R5	VHF R6-R12
UHF E21-E69	CATV (S01-S05)
CATV S1-S10 (M1-M10)	CATV S11-S20 (U1-U10)
CATV S21-S41 (HYPERBAND)	

Intermediate Frequency:

Video	38,9MHz, 34MHz
Sound	32,9MHz, 33,16MHz, 33,4MHz 40,4MHz, 32,4MHz (A2 STEREO) 33,05MHz, 34,05MHz (NICAM) 32,66MHz, 32,4MHz (CZECH STEREO)
Colour	34,47MHz (PAL) 34,5MHz, 34,65MHz (SECAM)

Video/Audio Terminals:

AUDIO MONITOR OUT	Audio (RCAx2)	500mV rms 1kΩ
AV1 IN	Video (21 pin)	1V p-p 75Ω
	Audio (21 pin)	500mV rms 10kΩ
	RGB (21 pin)	
AV1 OUT	Video (21 pin)	1V p-p 75Ω
	Audio (21 pin)	500mV rms 1kΩ
AV2 IN	Video (21 pin)	1V p-p 75Ω
	Audio (21 pin)	500mV rms 10kΩ
	S-Video IN	Y: 1V p-p 75Ω (21 pin) C: 0,3V p-p 75Ω
AV2 OUT	Video (21 pin)	1V p-p 75Ω
	Audio (21 pin)	500mV rms 1kΩ
	Selectable Output (21 pin)	
AV3 IN	Audio (RCAx2)	500mV rms 10kΩ
	Video (RCAx1)	1V p-p 75Ω

High Voltage:

Picture Tube: A66ECF50X82 66cm
{A59ECF50X82 59cm}

Audio Output:

2 x 15W (Music Power)
8Ω Impedance
Headphones 8Ω Impedance
Accessories supplied: Remote Control
2 x R6 (UM3) Batteries

Dimensions:

Height:	596,5mm	{550,5mm}
Width:	778mm	{730mm}
Depth:	481mm	{478,5mm}
Net Weight:	32kg	{27kg}

Specifications are subject to change without notice.

Weights and dimensions shown are approximate.

NOTE: This Service Manual should be used in conjunction with the EURO-4H technical guide.

TECHNISCHE DATEN

(Werte in klammern gelten { } nur für TX-25LD20F)

Netzspannung:	220-240V a.c., 50Hz
Leistungsaufnahme:	121W
Standby Leistungsaufnahme:	1,4W
Antennenimpedanz:	75Ω asymmetrisch, Koaxial-Typ
Empfangssystem:	PAL-B/G, H, I, D/K, PAL-525/60 SECAM B/G, D/K, L/L' M.NTSC NTSC (nur AV Eingang)

Empfangsbereiche:

VHF E2-E12	VHF H1-H2 (ITALY)
VHF A-H (ITALY)	VHF R1-R2
VHF R3-R5	VHF R6-R12
UHF E21-E69	CATV (S01-S05)
CATV S1-S10 (M1-M10)	CATV S11-S20 (U1-U10)
CATV S21-S41 (HYPERBAND)	

Zwischenfrequenz:

Video	38,9MHz, 34MHz
Sound	32,9MHz, 33,16MHz, 33,4MHz 40,4MHz, 32,4MHz (A2 STEREO) 33,05MHz, 34,05MHz (NICAM) 32,66MHz, 32,4MHz (CZECH STEREO)
Colour	34,47MHz (PAL) 34,5MHz, 34,65MHz (SECAM)

Video/Audio Anschlüsse:

AUDIO MONITOR OUT	Audio (RCAx2)	500mV rms 1kΩ
AV1 EINGANG	Video (21 pin)	1V p-p 75Ω
	Audio (21 pin)	500mV rms 10kΩ
	RGB (21 pin)	
AV1 AUSGANG	Video (21 pin)	1V p-p 75Ω
	Audio (21 pin)	500mV rms 1kΩ
AV2 EINGANG	Video (21 pin)	1V p-p 75Ω
	Audio (21 pin)	500mV rms 10kΩ
	S-Video IN	Y: 1V p-p 75Ω (21 pin) C: 0,3V p-p 75Ω
AV2 AUSGANG	Video (21 pin)	1V p-p 75Ω
	Audio (21 pin)	500mV rms 1kΩ
	Wählbarer Ausgang	
AV3 EINGANG	Audio (RCAx2)	500mV rms 10kΩ
	Video (RCAx1)	1V p-p 75Ω

Hochspannung:

Bildrohre: A66ECF50X82 66cm
{A59ECF50X82 59cm}

Ton Ausgangsleistung:

2 x 15W (Musikleistung)
Lautsprecher 8Ω Impedanz
Kopfhörer: 8Ω Impedanz
Mittel. Zubehör: Fernbedienung
2 x R6 (UM3) Batterien

Abmessungen:

Höhe:	596,5mm	{550,5mm}
Breite:	778mm	{730mm}
Tiefe:	481mm	{478,5mm}
Gewicht:	32kg	{27kg}

Änderungen der Technischen Daten vorbehalten.

Gewichte und Abmessungen sind Näherungsangaben.

Hinweis: Bitte verwenden Sie das Service Manual zusammen mit dem Technical Guide.

CONTENTS

SAFETY PRECAUTIONS	2
SERVICE HINTS	4
SELF CHECK	5
ADJUSTMENT PROCEDURE	6
WAVEFORM PATTERN TABLE	7
ALIGNMENT SETTINGS	8
BLOCK DIAGRAMS	10
PARTS LOCATION	14
REPLACEMENT PARTS LIST	15
SCHEMATIC DIAGRAMS	26
CONDUCTOR VIEWS	30

SAFETY PRECAUTIONS

GENERAL GUIDE LINES

1. It is advisable to insert an isolation transformer in the a.c. supply before servicing a hot chassis.
2. When servicing, observe the original lead dress in the high voltage circuits. If a short circuit is found, replace all parts which have been overheated or damaged by the short circuit.
3. After servicing, see that all the protective devices such as insulation barriers, insulation papers, shields and isolation R-C combinations are correctly installed.
4. When the receiver is not being used for a long period of time, unplug the power cord from the a.c. outlet.
5. Potentials as high as 29kV are present when this receiver is in operation. Operation of the receiver without the rear cover involves the danger of a shock hazard from the receiver power supply. Servicing should not be attempted by anyone who is not familiar with the precautions necessary when working on high voltage equipment. Always discharge the anode of the tube.
6. After servicing make the following leakage current checks to prevent the customer from being exposed to shock hazard.

LEAKAGE CURRENT COLD CHECK

1. Unplug the a.c. cord and connect a jumper between the two prongs of the plug.
2. Turn on the receiver's power switch.
3. Measure the resistance value with an ohmmeter, between the jumpered a.c. plug and each exposed metallic cabinet part on the receiver, such as screw heads, aerials, connectors, control shafts etc. When the exposed metallic part has a return path to the chassis the reading should be between 4M ohm and 20M ohm. When the exposed metal does not have a return path to the chassis the reading must be infinite.

INHALT

SICHERHEITSVORKEHRUNGEN	2
SERVICE HINWEISE	4
SELBSTDIAGNOSE	5
ABGLEICH	6
SIGNAL TABELLE	7
ABGLEICHTABELLE	9
SCHALTBILD BLOCK.....	10
EXPLOSIONSZEICHNUNG.....	14
ERSATZTEILLISTE	15
SCHALTBILD SCHEMA	26
ANSICHT DER LEITERBAHNEN	30

SICHERHEITSVORKEHRUNGEN

ALLGEMEINE RICHTLINIEN

1. Es ist empfehlenswert einen Trenntransformator in die Stromversorgung zu schalten, bevor Reparaturen an einem Gerät vorgenommen werden, dessen Chassis unter Spannung steht.
2. Bei der Durchführung von Servicearbeiten dürfen die ursprünglichen Kabelanschlüsse nicht vertauscht werden. Dies gilt insbesondere für die Anschlüsse im Hochspannungsteil. Hat sich ein Kurzschluß ereignet, dann sind alle Teile, an denen Spuren von Überhitzung sichtbar sind, auszuwechseln.
3. Nach Beenden der Servicearbeiten ist sicherzustellen, daß alle Sicherheitsvorrichtungen, wie Isolationsstege, Isolationspapiere, Abschirmungen und Isolations -R-C- Glieder wieder richtig eingesetzt sind.
4. Wenn der Fernseher während längerer Zeit nicht in Betrieb gesetzt wird, sollte der Netzstecker aus der Netzsteckdose gezogen werden.
5. Im Betrieb sind Spannungen bis zu 29kV in diesem Gerät vorhanden. Die Inbetriebnahme des Fernsehers ohne aufgesetzte Rückwand bringt die Gefahr eines elektrischen Schlages von der Fernseher - Stromversorgung mit sich. Servicearbeiten sollten daher auch nie durch Personen versucht werden, die nicht in vollem Umfang mit den Sicherheitsvorkehrungen beim Umgang mit Hochspannungsgeräten vertraut sind. Vor der Handhabung mit der Bildröhre ist die Anode der Bildröhre immer an dem Empfängerchassis zu entladen.
6. Nach Beenden der Servicearbeiten sind die folgenden Kriechstrom-Prüfungen durchzuführen, um den Kunden vor der Gefahr eines elektrischen Schlages zu schützen.

MESSUNG DES ISOLATIONSWIDERSTANDES IM ABGESCHALTETEN ZUSTAND

1. Den Netzstecker aus der Netzsteckdose ziehen und die beiden Steckerstifte kurzschließen.
2. Den Geräteschalter des Fernsehgerätes einschalten.
3. Mit einem Ohmmeter den Widerstandswert zwischen dem überbrückten Netzkabelstecker und jedem zugänglichen Metallteil am Gehäuse des Fernsehgerätes, wie Schraubenköpfe, Antennen, Achsen der Regler, Griffassungen usw. messen. Wenn ein zugängliches Metallteil keine Rückleitung zum Chassis hat, muß die Anzeige unendlich betragen.

LEAKAGE CURRENT HOT CHECK

1. Plug the a.c. cord directly into the a.c. outlet. Do not use an isolation transformer for this check.
2. Connect a $2k\Omega$ 10W resistor in series with an exposed metallic part on the receiver and an earth, such as a water pipe.
3. Use an a.c. voltmeter with high impedance to measure the potential across the resistor.
4. Check each exposed metallic part and check the voltage at each point.
5. Reverse the a.c. plug at the outlet and repeat each of the above measurements.
6. The potential at any point should not exceed 1,4V rms. In case a measurement is outside the limits specified, there is a possibility of a shock hazard, and the receiver should be repaired and rechecked before it is returned to the customer.

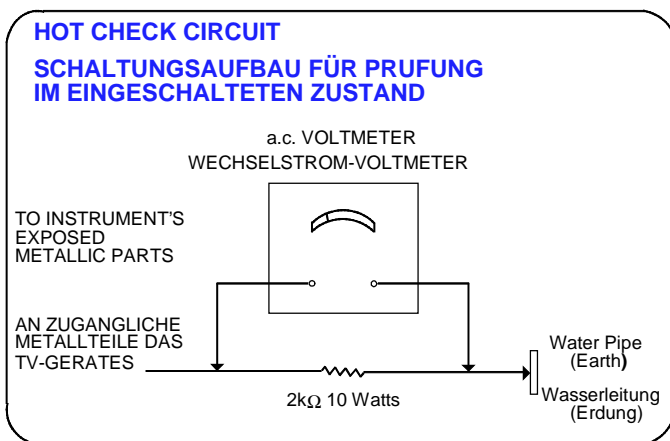

Fig.1.
Abb.1.

X-RADIATION WARNING

1. The potential sources of X-Radiation in TV sets are the high voltage section and the picture tube.
2. When using a picture tube test jig for service, ensure that the jig is capable of handling 29kV without causing X-Radiation.

NOTE : It is important to use an accurate periodically calibrated high voltage meter.

1. Set the brightness to minimum.
2. Measure the high voltage. The meter should indicate: $28kV \pm 1kV$. If the meter indication is out of tolerance, immediate service and correction is required to prevent the possibility of premature component failure.
3. To prevent any X-Radiation possibility, it is essential to use the specified tube.

MESSUNG DES KRIECHSTROMS IM EINGESCHALTETEN ZUSTAND

1. Den Netzstecker direkt in eine Netzsteckdose stecken. Für diese Messung keinen Trenntransformator verwenden.
2. Einen $2k\Omega$ / 10W-Widerstand in Serie mit einem von außen zugänglichen Metallteil am Fernsehgerät und einer guten, Erdung z.B Wasserleitung, anschließen.
3. Ein Wechselstrom-Voltmeter mit einem Meßbereich von 1000 Ohm.Volt oder größer verwenden, um die Spannung über den Widerstand zu messen.
4. Jedes zugängliche Metallteil prüfen, und an jedem Punkt dies Spannung messen.
5. Den Netzstecker umgekehrt in die Steckdose stecken und jede der obigen Messungen wiederholen.
6. Die Spannung darf an keinem der Punkte 1,4V eff. überschreiten. Wird dieser Wert nicht eingehalten, besteht die Gefahr eines elektrischen Schlages, und das Fernsehgerät sollte daher repariert und nachgeprüft werden, bevor es an den Kunden zurückgegeben wird.

RÖNTGENSTRAHLUNG ACHTUNG :

1. Potentielle Quellen von Röntgenstrahlung in Fernsehgeräten sind das Hochspannungsteil und die Bildröhre.
2. Bei Verwendung eines Bildröhren-Prüfgerätes für den Service ist sicherzustellen, daß es für die Belastung von 29kV geeignet ist, ohne daß eine Röntgenstrahlung verursacht wird.

ANMERKUNG : Es ist wichtig, daß ein präzises, regelmäßig geprüftes Voltmeter verwendet wird.

1. Helligkeit auf Minimum stellen.
2. Die Hochspannung messen. Die Anzeige des Instrumentes sollte: $28kV \pm 1kV$. Falls die Anzeige diese Toleranzgrenzen überschreitet, ist die sofortige Behebung nötig, um die Möglichkeit vorzeitigen Komponentenausfalls zu verhüten.
3. Um die Möglichkeit von Röntgenstrahlung zu begrenzen, ist es wichtig, daß nur die vorgeschriebene Bildröhre verwendet wird.

SERVICE HINTS HOW TO REMOVE THE REAR COVER

1. Remove the 11 screws as shown in **Fig. 2.**

SERVICE HINWEISE ENTFERNEN DER GERÄTERÜCKWAND

1. Die 11 Schrauben entfernen, siehe **Abb. 2.**



Fig. 2.
Abb. 2.

LOCATION OF CONTROLS

LAGE DER EINSTELLREGLER

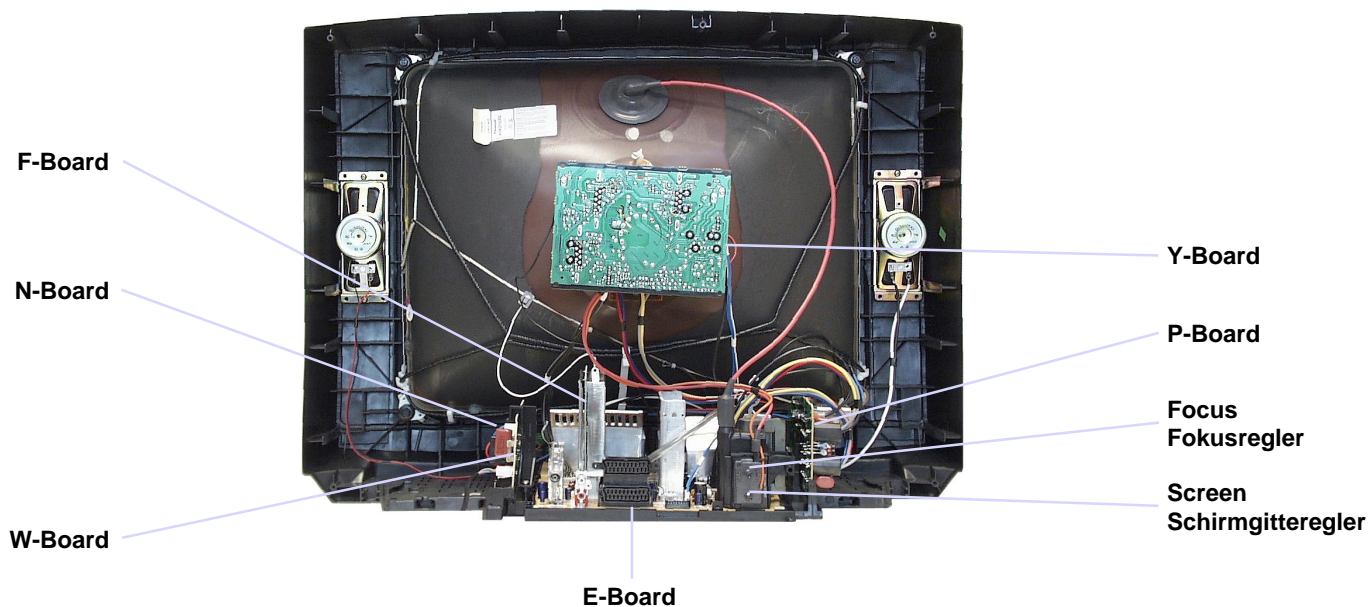

Fig. 3.
Abb. 3.

SELF CHECK

1. Self-check is used to automatically check the bus lines and hexadecimal code of the TV set.
2. To get into the Self-Check mode press the down (-/V) button on the customer controls at the front of the set, at the same time pressing the **STATUS** button on the remote control, and the screen will show :-

SELBSTDIAGNOSE

1. Die Selbstdiagnose dient zum automatischen Prüfen der Bus-Leitungen sowie des Hexadezimalcodes des FS-Geräts. Zum Umschalten auf Selbstdiagnose zunächst die Taste "**STATUS**" auf der Fernbedienung und gleichzeitig die-Taste am Bedienteil des FS-Gerätes drücken (-/V), auf dem Bildschirm erscheint hierauf :-
2. Nach der Selbstdiagnose wird das Gerät automatisch auf sämtliche werksseitigen Standardeinstellungen zurückgesetzt :-

VPC	O.K.	PCB	O.K.
CIP	O.K.	Cab	O.K.
SRC	O.K.		
DDP	O.K.		
TUN	O.K.		
E2	O.K.		
MSP	O.K.		
DPL	--		
OPTION1	39		
OPTION2	1C		
OPTION3	1F		
OPTION4	00		
OPTION5	EF		
OPTION6	A5		

If the CCU ports have been checked and found to be incorrect or not located then " - - " will appear in place of "O.K.". Wenn der Hauptprozessor (CCU) an den Anschlüssen einen Fehler erkennt, oder der entsprechende Anschluss nicht belegt ist, zeigt die entsprechende Position " - - " anstelle von OK an.

Service Aids

To aid in the service of our current chassis there are a number of Service Aids which have been made available.

- **LUCI** interface kit (**L**inked **U**tility **C**omputer **I**nterface)
Part number: TZS6EZ002
This contains interface and cables for connecting TV service connector and a PC as well as diagnostic software. As new models are introduced upgrade software will become available.
- **VICI** (**V**isual **I**nteractive **C**omputer **I**nformation)
These C.D.'s contain multimedia documentation providing quick access to service information.
Part No. TZS7EZ006, TZS7EZ005 & TZS8EZ001
1. Service Manuals
2. Instruction Books
3. Technical Information
- **TASMIN** (**T**echnically **A**dvanced **S**ystem for **M**ultimedia **I**nteractive **N**otes)
As well as providing a first step towards more interactive training this product also achieves quick access to Technical Information.
- To assist in servicing of the F-board, an extension lead kit is available, part no. TZS9EK008.

Service-Hilfen

Zur Unterstützung der Servicearbeiten stehen weitere Hilfsmittel zur Verfügung.

- **LUCI** interface kit (PC-unterstütztes Diagnosesystem)
Bestell-Nr.: TZS6EZ002
Es beinhaltet ein Interface, die Anschlusskabel zum FS-Gerät und die Diagnose-Software. Bei Einführung von neuen Modellen ist ein Update der Software jederzeit möglich.
- **VICI** (Interaktive CD-ROM) mit schnellem Zugriff auf Serviceinformationen.
Bestell-Nr.:TZS7EZ006, TZS7EZ005 & TZS8EZ001
1. Service Manuals
2. Bedienungsanleitungen
3. Technical Information
- **TASMIN** (Technisch erweitertes System für interaktive Multimedia-Hinweise und Notizen)
Genauso wie dieses Produkt einen ersten Schritt in Richtung erweitertes interaktives Training bereitstellt, ermöglicht es einen noch schnelleren Zugang zu technischen Informationen.
- Um Servicearbeiten auf dem F-Bord durchzuführen, steht ein Satz Verlängerungskabel unter der Bestellnummer TZS9EK008 zur Verfügung.

ADJUSTMENT PROCEDURE

Item/Preparation	Adjustments																																										
<p style="text-align: center;">+B SET-UP</p> <ol style="list-style-type: none"> 1. Receive a Greyscale signal. 2. Set the controls:- <table style="margin-left: 20px;"> <tr> <td>Brightness</td> <td>Minimum</td> </tr> <tr> <td>Contrast</td> <td>Minimum</td> </tr> <tr> <td>Volume</td> <td>Minimum</td> </tr> </table> 	Brightness	Minimum	Contrast	Minimum	Volume	Minimum	<ol style="list-style-type: none"> 1. Set the +B voltage up as follows:- Adjust R811 so that B2 shows $148V \pm 1V$ 2. Confirm the following voltages. <table style="margin-left: 20px;"> <tr> <td>B9</td> <td>5</td> <td>$\pm 0,25V$</td> <td>B10</td> <td>5</td> <td>$\pm 0,25V$</td> </tr> <tr> <td>B5</td> <td>12</td> <td>$\pm 0,5V$</td> <td>B11</td> <td>33</td> <td>$\pm 1,5V$</td> </tr> <tr> <td>B4</td> <td>16</td> <td>$\pm 1V$</td> <td>B7</td> <td>8</td> <td>$\pm 0,5V$</td> </tr> <tr> <td>B12</td> <td>26</td> <td>$\pm 2V$</td> <td>B8</td> <td>6</td> <td>$\pm 0,5V$</td> </tr> <tr> <td>B3</td> <td>36</td> <td>$\pm 1,5V$</td> <td>B13</td> <td>13</td> <td>$\pm 1V$</td> </tr> <tr> <td>B1</td> <td>205</td> <td>$\pm 10V$</td> <td>B14</td> <td>14</td> <td>$\pm 1V$</td> </tr> </table> 	B9	5	$\pm 0,25V$	B10	5	$\pm 0,25V$	B5	12	$\pm 0,5V$	B11	33	$\pm 1,5V$	B4	16	$\pm 1V$	B7	8	$\pm 0,5V$	B12	26	$\pm 2V$	B8	6	$\pm 0,5V$	B3	36	$\pm 1,5V$	B13	13	$\pm 1V$	B1	205	$\pm 10V$	B14	14	$\pm 1V$
Brightness	Minimum																																										
Contrast	Minimum																																										
Volume	Minimum																																										
B9	5	$\pm 0,25V$	B10	5	$\pm 0,25V$																																						
B5	12	$\pm 0,5V$	B11	33	$\pm 1,5V$																																						
B4	16	$\pm 1V$	B7	8	$\pm 0,5V$																																						
B12	26	$\pm 2V$	B8	6	$\pm 0,5V$																																						
B3	36	$\pm 1,5V$	B13	13	$\pm 1V$																																						
B1	205	$\pm 10V$	B14	14	$\pm 1V$																																						
<p style="text-align: center;">Cut-Off / Ug2 Test</p> <ol style="list-style-type: none"> 1. Receive a Greyscale signal. 2. Degauss the tube externally. 3. Set the TV into Service Mode 1. 4. Select Cutoff mode. 	<p>To adjust Cutoff connect an oscilloscope to the Blue cathode. Press "STR" and adjust "cutoff" value using the "Yellow" and "Blue" buttons until the black level is $160V \pm 5V$, press "STR" to store the value. Remove the oscilloscope.</p> <p>Select Ug2 adjustment and adjust the screen VR until the display shows "O.K."</p>																																										

ABGLEICH

Vorbereitungen	Abgleich																																										
<p style="text-align: center;">+B - Abgleich</p> <ol style="list-style-type: none"> 1. Testbild empfangen. <table style="margin-left: 20px;"> <tr> <td>Helligkeit auf</td> <td>Minimum</td> </tr> <tr> <td>Kontrast auf</td> <td>Minimum</td> </tr> <tr> <td>Lautstärke</td> <td>Minimum</td> </tr> </table> 	Helligkeit auf	Minimum	Kontrast auf	Minimum	Lautstärke	Minimum	<ol style="list-style-type: none"> 1. Mit R811 muß die B2 auf $148V \pm 1V$ eingestellt werden. 2. Folgende Spannungen sind zu überprüfen. <table style="margin-left: 20px;"> <tr> <td>B9</td> <td>5</td> <td>$\pm 0,25V$</td> <td>B10</td> <td>5</td> <td>$\pm 0,25V$</td> </tr> <tr> <td>B5</td> <td>12</td> <td>$\pm 0,5V$</td> <td>B11</td> <td>33</td> <td>$\pm 1,5V$</td> </tr> <tr> <td>B4</td> <td>16</td> <td>$\pm 1V$</td> <td>B7</td> <td>8</td> <td>$\pm 0,5V$</td> </tr> <tr> <td>B12</td> <td>26</td> <td>$\pm 2V$</td> <td>B8</td> <td>6</td> <td>$\pm 0,5V$</td> </tr> <tr> <td>B3</td> <td>36</td> <td>$\pm 1,5V$</td> <td>B13</td> <td>13</td> <td>$\pm 1V$</td> </tr> <tr> <td>B1</td> <td>205</td> <td>$\pm 10V$</td> <td>B14</td> <td>14</td> <td>$\pm 1V$</td> </tr> </table> 	B9	5	$\pm 0,25V$	B10	5	$\pm 0,25V$	B5	12	$\pm 0,5V$	B11	33	$\pm 1,5V$	B4	16	$\pm 1V$	B7	8	$\pm 0,5V$	B12	26	$\pm 2V$	B8	6	$\pm 0,5V$	B3	36	$\pm 1,5V$	B13	13	$\pm 1V$	B1	205	$\pm 10V$	B14	14	$\pm 1V$
Helligkeit auf	Minimum																																										
Kontrast auf	Minimum																																										
Lautstärke	Minimum																																										
B9	5	$\pm 0,25V$	B10	5	$\pm 0,25V$																																						
B5	12	$\pm 0,5V$	B11	33	$\pm 1,5V$																																						
B4	16	$\pm 1V$	B7	8	$\pm 0,5V$																																						
B12	26	$\pm 2V$	B8	6	$\pm 0,5V$																																						
B3	36	$\pm 1,5V$	B13	13	$\pm 1V$																																						
B1	205	$\pm 10V$	B14	14	$\pm 1V$																																						
<p style="text-align: center;">Cut-Off / Ug2 Test</p> <ol style="list-style-type: none"> 1. Testbild empfangen. 2. Bildröhre entmagnetisieren. 3. Service-Mode 1 anwählen. 4. Im Service-Mode den Abgleichpunkt Cutoff DC-Mode wählen. 	<p>Einen Oszillographen an die blaue Katode der Bildröhre anschliessen. STR-Taste drücken und Mit der gelben und blauen Taste den CUT-OFF Wert auf $160V \pm 5V$ abgleichen und mit der STR-Taste abspeichern. Den Oszillograph entfernen und den Ug2 Test aufrufen. Den Abgleichwert solange ändern, bis OK auf dem Bildschirm erscheint. Den Wert abspeichern.</p>																																										

WAVEFORM PATTERN TABLE

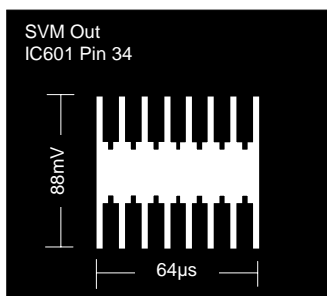
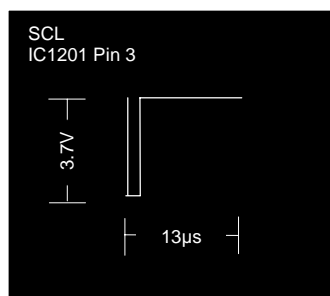
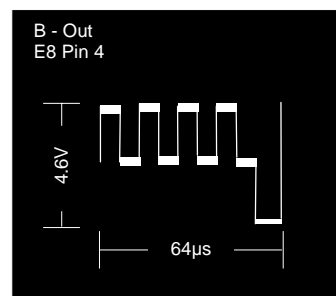
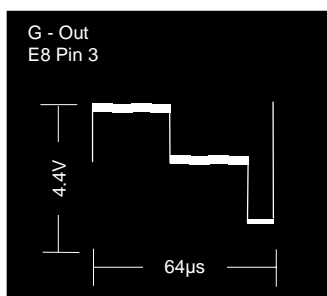
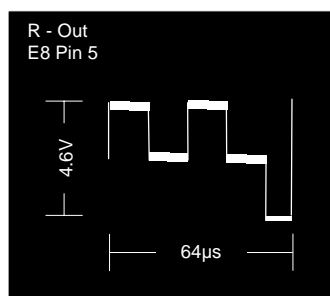
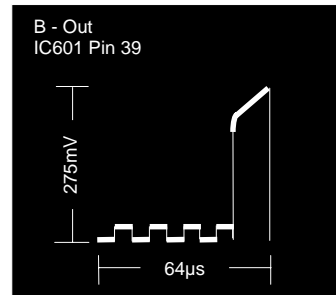
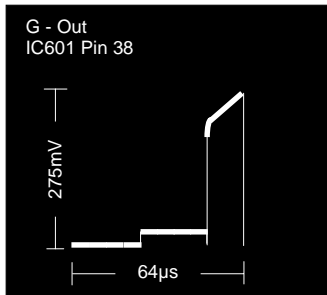
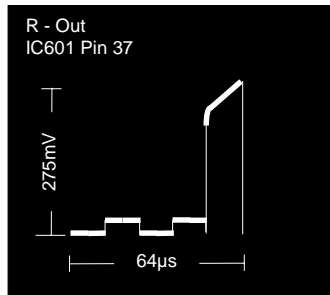
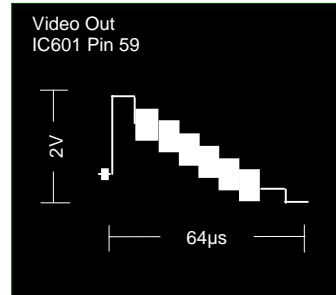
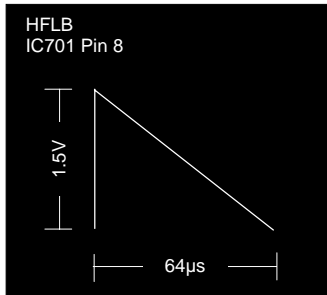
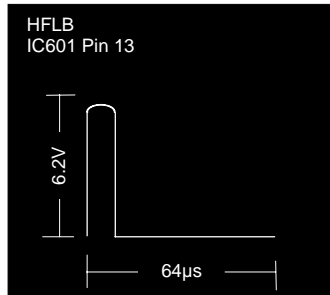
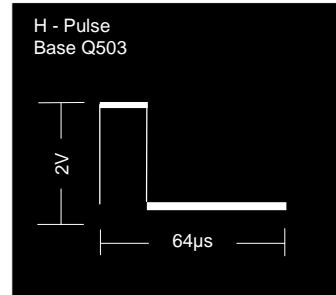
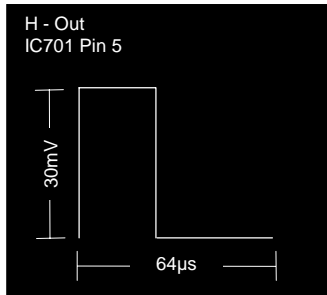
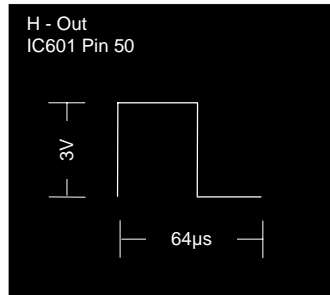
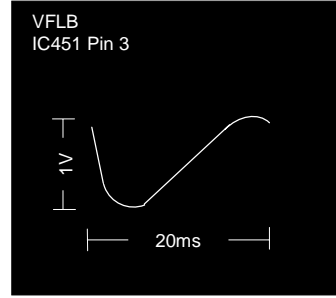
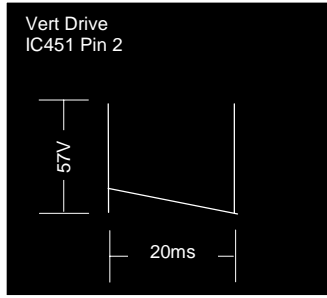
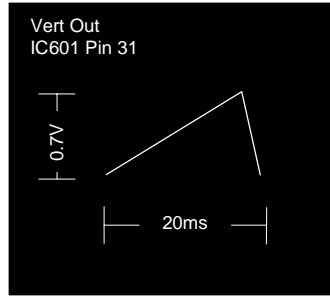

SIGNAL TABELLE

ALIGNMENT SETTINGS:

(The figures below are nominal and used for representative purposes only.)

1. Set the Bass to maximum position, set the Treble to minimum position, press the volume down button (-V) on the customer controls at the front of the TV and at the same time press the **INDEX** button on the remote control, this will place the TV into the Service Mode.
2. Press the **RED / GREEN** buttons to step up / down through the functions.
3. Press the **YELLOW / BLUE** buttons to alter the function values.
4. Press the **STR** button after each adjustment has been made to store the required values.
5. To exit the Service Mode, press the **"N"** button.

Alignment Function		Settings / Special features
Horizontal Position	H-Pos 061	Optimum setting.
Vertical Position	V-Pos 005	Optimum setting.
Horizontal Amplitude	H-Amp 055	Optimum setting.
Vert. Amplitude	V. Amp 054	Optimum setting.
EW-amplitude	E/W-Amp1 -128	Optimum setting.
EW-amplitude	E/W-Amp2 006	Optimum setting.
Trapezium-comp	Trapez-1 047	Optimum setting.
Trapezium-comp	Trapez-2 -128	Optimum setting.
Vertical Linearity	V-Lin 006	Optimum setting.
Vertical Symmetry	V-Sym 002	Optimum setting.
DVCO	DVCO -005	Receive a PAL Colour Bar Pattern. For DVCO alignment press "Blue" button, wait until the colours are changing slowly and press "STR" .
Cut-off DC	Cut-off 0171	To adjust Cutoff connect an oscilloscope to the Blue cathode. Press "STR" and adjust "cutoff" value using the "Yellow" and "Blue" buttons until the black level is $160V \pm 5V$, press "STR" to store the value. Remove the oscilloscope. Select Ug2 adjustment and adjust the screen VR until the display shows "O.K."
Ug2 Test	Ug2 055 O.K.	
Highlight Lowlight	High 0902 0777 0864 Low 0117 0132 0112	Optimum setting.
Sub-Brightness	Sub-Brightness 255	Optimum setting.

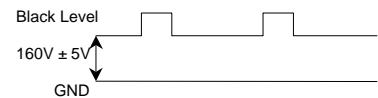

ABGLEICHTABELLE

(Die angegebenen Werte sind Mittelwerte und Können individuell nach oben oder unten nach dem korrekten Abgleich abweichen.)

1. Um in den Service-Mode zu gelangen, gehen sie bitte wie folgt vor.
2. Stellen sie im Toneinstellungs-Menü die Bässe auf Maximun und die Höhen auf Minimum.
3. Halten sie die **INDEX**-Taste auf der Fernbedienung gedrückt und drücken zusätzlich die Taste **-V** im Bedienteil des TV-Gerätes. Auf dem Bildschirm erscheint die entsprechende Anzeige für den Service-Mode.
4. Die einzelnen Funktionen mit Hilfe der **ROTEN** und **GRÜNEN** Taste anwählen.
5. Mit der **GELBEN** und **BLAUEN** Taste die Werte der einzelnen Funktionen ändern.
6. Nach jeder Einstellung die Taste **STR** auf der Fernbedienung drücken, um die geänderten Werte abzuspeichern.
7. Zum Verlassen des Service-Modus die **"N"** - Taste auf der Fernbedienung drücken.

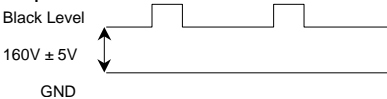
Abgleichfunktion		Einstellung / Besondere Merkmale
Horizontale position	H-Pos 061	Optimale Einstellung.
Vertikale Position	V-Pos 005	Optimale Einstellung.
Horizontale Amplitude	H-Amp 055	Optimale Einstellung.
Vertikale Amplitude	V-Amp 054	Optimale Einstellung.
OW-amplitude	E/W-Amp1 -128	Optimale Einstellung.
OW-amplitude	E/W-Amp2 006	Optimale Einstellung.
Trapez-Kompensation	Trapez-1 047	Optimale Einstellung.
Trapez-Kompensation	Trapez-2 -128	Optimale Einstellung.
Vertikale linearität	V-Lin 006	Optimale Einstellung.
Vertikale Symmetrie	V-Sym 002	Optimale Einstellung.
DVCO	DVCO -005	Ein Farbbalken-Testbild empfangen. Zum Abgleich des Farboszillators (DVCO) die blau Taste drücken. Nachdem ein leichtes Flackern in den Farbbalken zum Stillstand gekommen ist, die STR -Taste drücken.
Cut-off	Cut-off 0171	Einen Oszillographen an die blaue Katode der Bildröhre anschliessen. STR -Taste drücken und Mit der gelben und blauen Taste den CUT-OFF Wert auf $160V \pm 5V$ abgleichen und mit der STR -Taste abspeichern. Den Oszillograph entfernen und den Ug2 Test aufrufen. Den Abgleichwert solange ändern, bis OK auf dem Bildschirm erscheint. Den Wert abspeichern.
Ug2 Test	Ug2 055 O.K.	
Highlight Lowlight	High 0902 0777 0864 Low 0117 0132 0112	Optimale Einstellung.
Sub-Brightness	Sub-Brightness 255	Optimale Einstellung.

VIDEO BLOCK DIAGRAM

BILD SIGNAL BLOCKSCHEMA

10

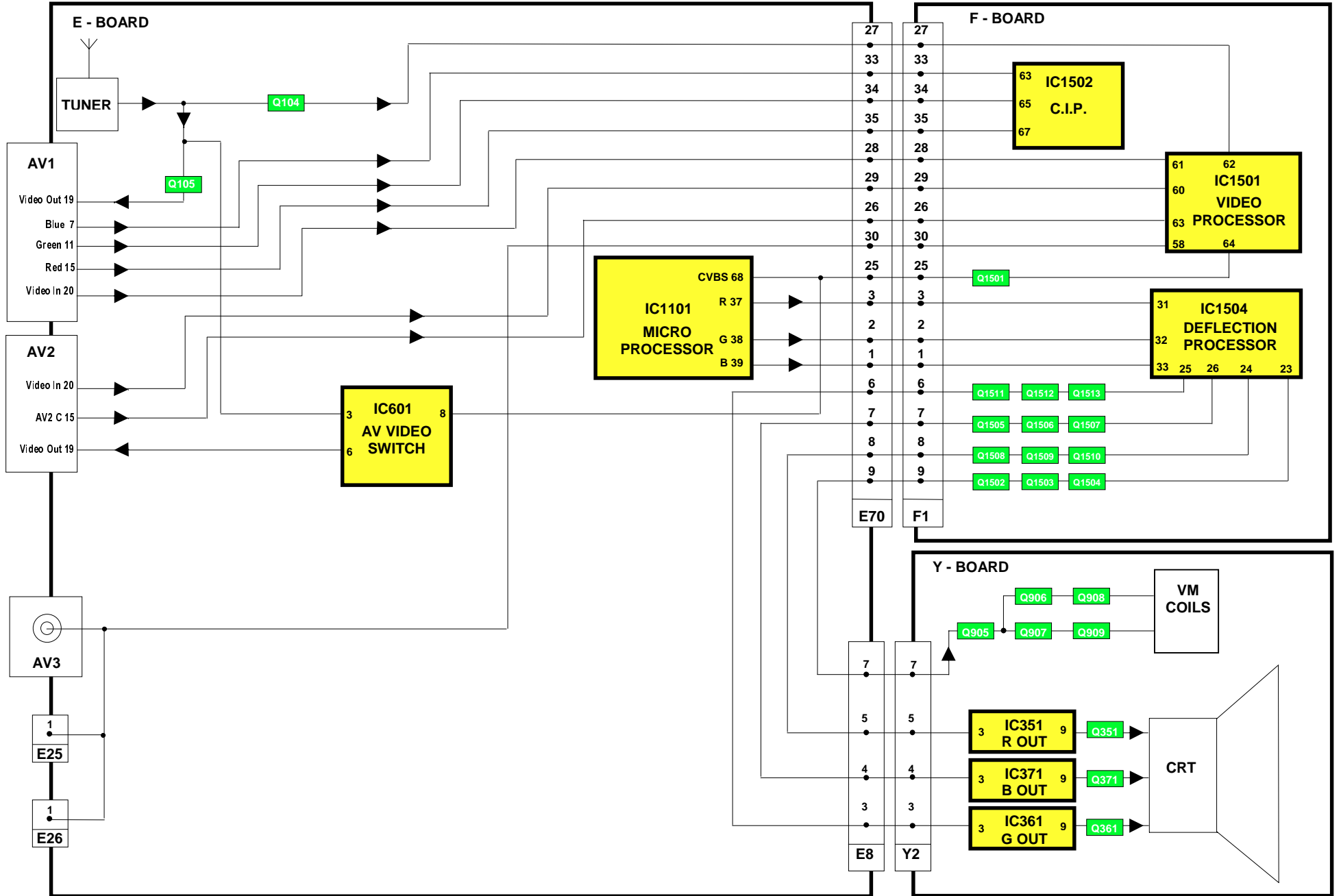

AUDIO BLOCK DIAGRAM

TONSIGNAL BLOCKSCHEMA

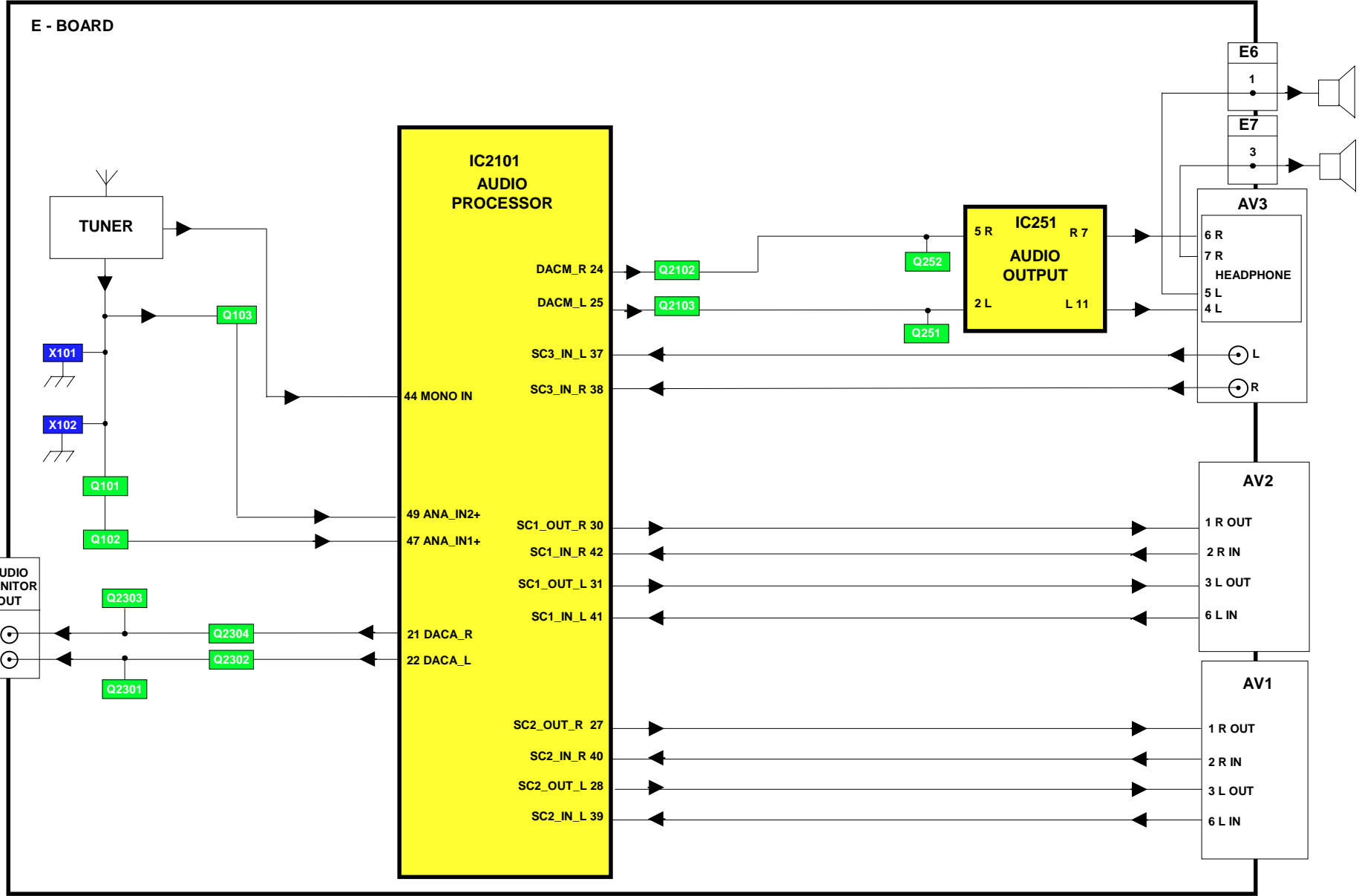

11

CONTROL BLOCK DIAGRAM

STROMVERSORGUNGS BLOCKSCHEMA

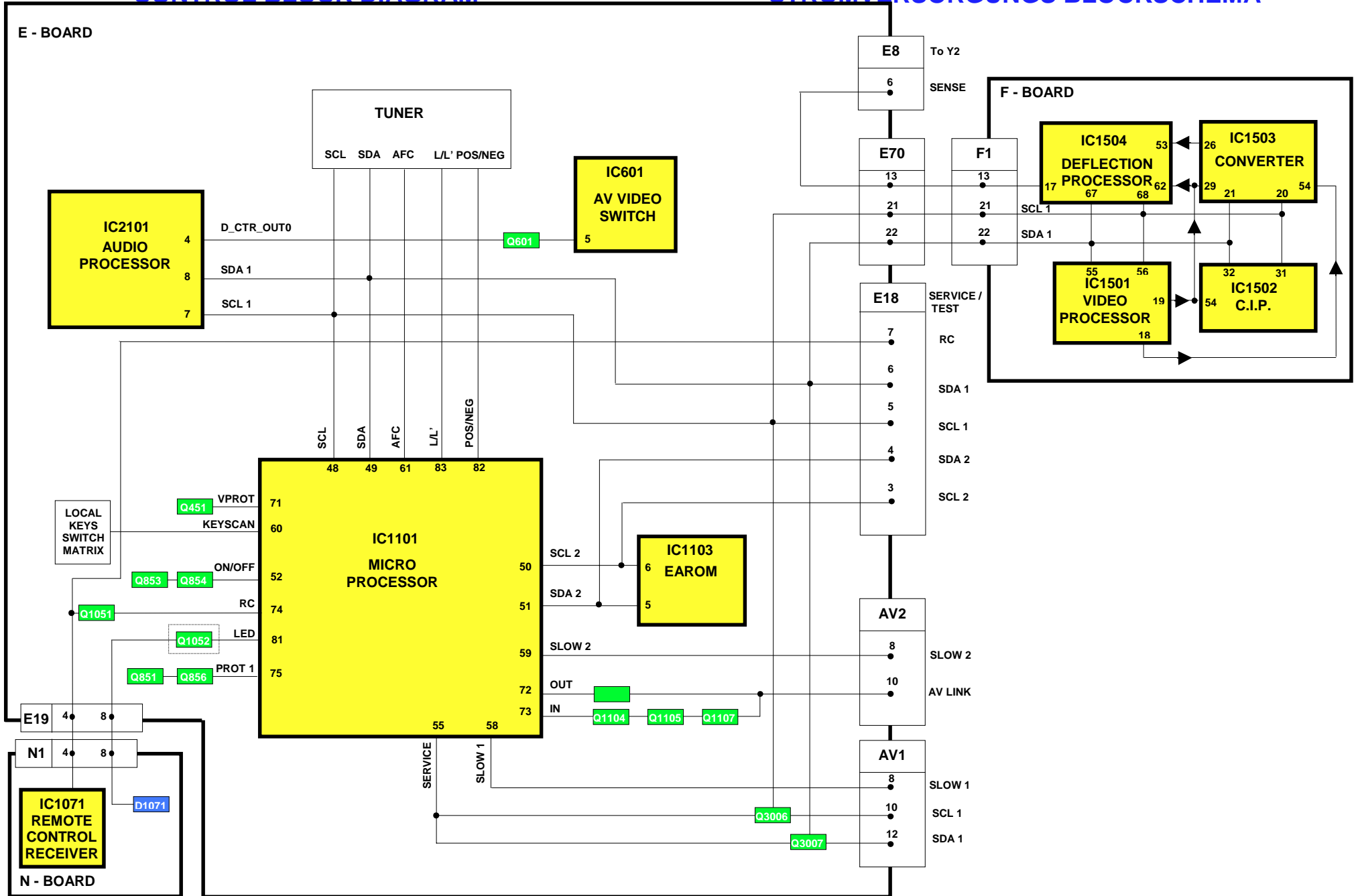

POWER SUPPLY BLOCK DIAGRAM

STROMVERSORGUNGS BLOCKSCHEMA

13

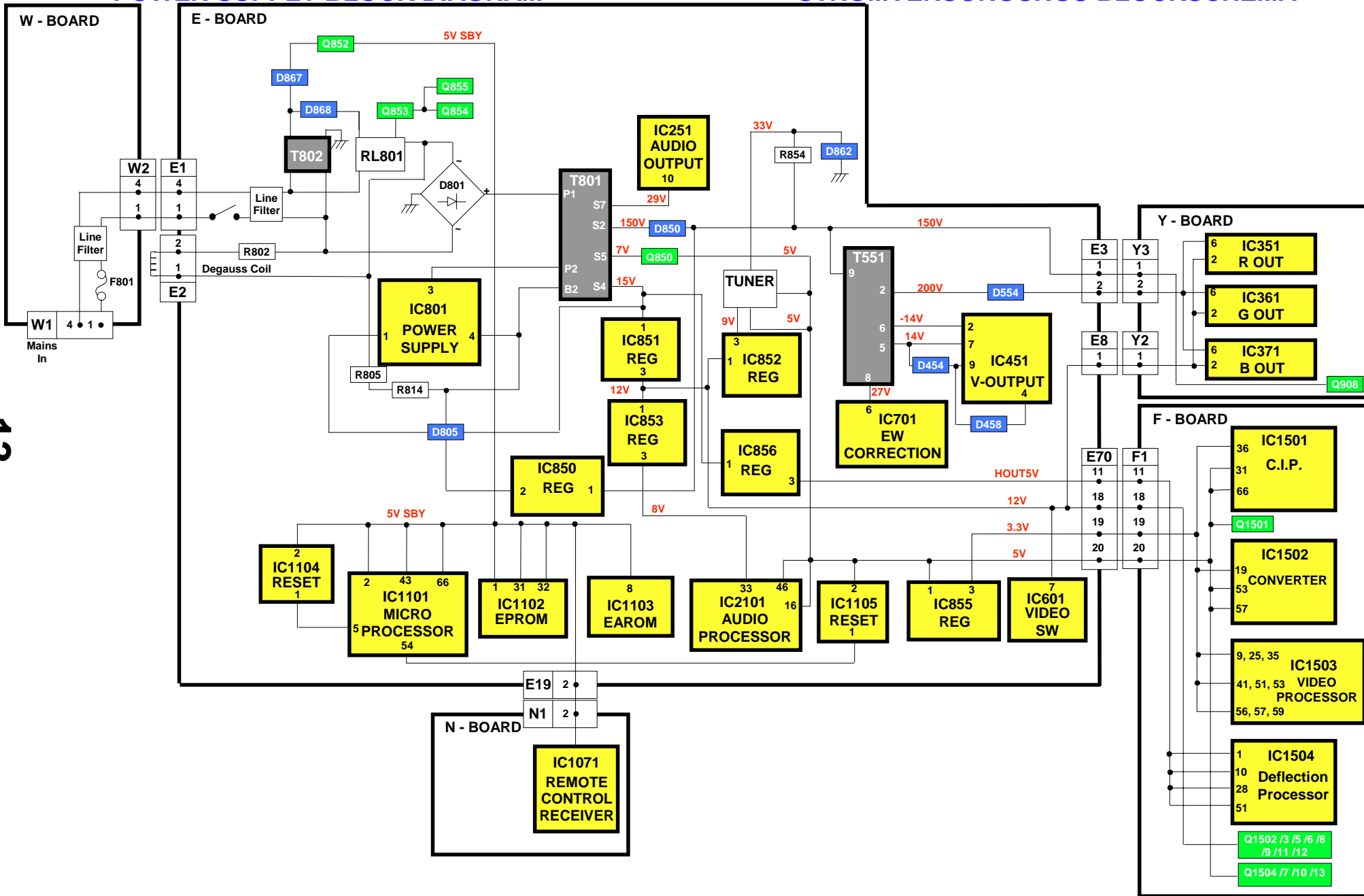

PARTS LOCATION

EXPLOSIONSZEICHNUNG

NOTE:

The numbers on the exploded view below refer to the mechanical section of the Replacement Parts List.

Anmerkung:

Die Nummer auf den mechanischen Teilen zeigt die Bezugsnummer der Ersatzteilliste an.

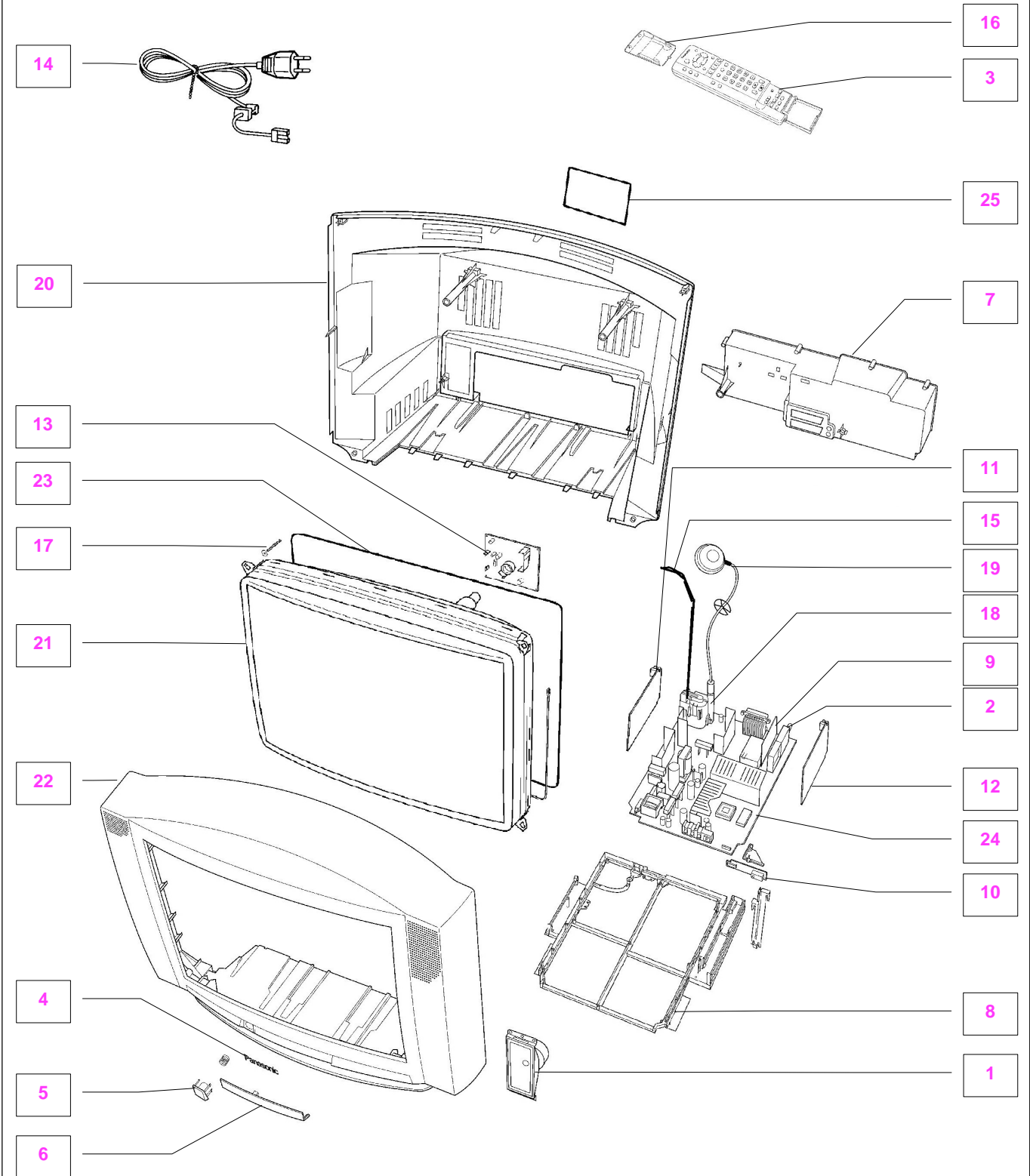

REPLACEMENT PARTS LIST

Important Safety Notice

Components Identified by  mark have special characteristics important for safety.

When replacing any of these components, use only manufacturers specified parts.

















* In case of ordering these spare parts, please always add the complete Model-Type number to your order.

ERSATZTEILLISTE

Wichtiger Sicherheitshinweis

Teile, die mit einem Hinweis  gekennzeichnet sind wichtig für die Sicherheit. Solite ein Auswechsein erforderlich sein, sind unbedingt Originalteile einzusetzen.

Bei der Bestellung von Ersatzteilen, die mit * gekennzeichnet sind, geben Sie bitte unbedingt die vollständige Typenbezeichnung mit an.

Cct Ref	Parts Number	Description
COMMON PARTS		
MECHANICAL PARTS		
1	EASG15S505A2	SPEAKER
2	ENG29505GR	TUNER 
3	EUR511211	REMOTE CONTROL
4	TBM8E1929	PANASONIC BADGE
5	TBX8E050	POWER BUTTON
6	TKP8E1223	DOOR LID
7	TKP8E1296-1	REAR AV PANEL
8	TMX8E042	CHASSIS FRAME
9	TNP8EF007AA	F P.C.B. 
10	TNP8EN016AA	N P.C.B. 
11	TNP8EP017AA	P P.C.B. 
12	TNP8EW002AA	W P.C.B. 
13	TNP8EY018AA	Y P.C.B. 
14	TSX8E0027	POWER CORD 
15	TXJ/FCODEG	FOCUS LEAD ASSY 
16	UR51EC904A	BATTERY COVER (REMOTE)
17	VP17005-32	CRT FIXING SCREW
18	ZTFM05008A	F.B.T. 
19	ZTUZAE550A	ANODE LEAD 
MISCELLANEOUS COMPONENTS		
	31221212478	FIX CLIP
	832AG11D-ESL	IC SOCKET
	927925-1	EARTH CLAMPER
	F9-4-220	RELAY
	PCSZT-084A-1	IC SOCKET
	TBM8E1615	PRESET LABEL
	TEK6940	LID CATCH
	TES8E015	POWER BUTTON SPRING
	TMW8E027	LED HOLDER
	UM-3DJ-2P	BATTERY PACK
PCH2	TMX8E041	PCB BRACKET
PCH3	TMX8E041	PCB BRACKET
R802	232266296706	THERMISTOR 
INSTRUCTION BOOKS		
	TQB8E2816A-1	GERMAN 
	TQB8E2816BD1	DUTCH/FRENCH 
	TQB8E2816CE2	ITALIAN/SPANISH 
	TQB8E2816FG1	SWEDISH/NORG. 
	TQB8E2816HK1	SUOMI/DANISH 
I.C.s		
IC251	LA4282	AUDIO OUTPUT
IC351	TDA6111Q-N4	RGB OUTPUT
IC361	TDA6111Q-N4	RGB OUTPUT
IC371	TDA6111Q-N4	RGB OUTPUT

Cct Ref	Parts Number	Description
IC381	TL431CLPM	REGULATOR
IC451	LA7876N	VERTICAL OUTPUT
IC601	TEA2114	VIDEO SWITCHING
IC701	TEA2031A	E/W CORRECTION
IC801	STRF6654LF57	POWER SUPPLY
IC850	SE140N	ERROR AMPLIFIER
IC851	L78M12MRB	12V REGULATOR
IC852	L78M09MRB	9V REGULATOR
IC853	AN78L08TA	8V REGULATOR
IC855	BA033T-M3	REGULATOR
IC856	AN7805LB	5V REGULATOR
IC1071	RPM6937-V4	LED RECEIVER
IC1101	SDA5450C59	MICRO PROCESSOR
IC1102	27C2001-M04	EPROM *
IC1104	MN1381-R(TA)	RESET
IC1105	MN1381-T(TA)	RESET
IC1501	VPC3215CB8TP	VIDEO PROCESSOR
IC1502	CIP3250APSB1	C.I.P.
IC1503	SDA9401	MICRO PROCESSOR
IC1504	DDP3310BPSD3	VIDEO PROCESSOR
IC2101	MSP3410DPOCS	AUDIO PROCESSOR
FUSES		
F801	19181-3.15	FUSE 
F8011	EYF52BC	FUSE HOLDER
F8012	EYF52BC	FUSE HOLDER
DIODES		
D101	MA3020TX	DIODE
D102	MA3020TX	DIODE
D251	MA2180BLFS	DIODE
D253	MA700TA5	DIODE
D254	MA700TA5	DIODE
D351	ERA15-04V3	DIODE
D352	ERA15-04V3	DIODE
D361	ERA15-04V3	DIODE
D362	ERA15-04V3	DIODE
D371	ERA15-04V3	DIODE
D372	ERA15-04V3	DIODE
D376	MA165TA5	DIODE
D377	MA165TA5	DIODE
D378	MA165TA5	DIODE
D387	MA2160LFS	DIODE
D453	MA165TA5	DIODE
D454	EU02	DIODE
D456	MTZJT-775.6C	DIODE
D457	MA165TA5	DIODE
D458	EU02	DIODE
D501	MA165TA5	DIODE
D502	1SR124-4AT82	DIODE
D511	MA4047	DIODE
D553	1SR124-4AT82	DIODE
D554	1SR124-4AT82	DIODE
D556	MA165TA5	DIODE

Cct Ref	Parts Number	Description
D557	TVSRU2AMLFA5	DIODE
D558	EU02	DIODE
D560	RH3GLF102	DIODE
D580	FMV-3GULF730	DIODE
D601	MA165TA5	DIODE
D602	MA165TA5	DIODE
D603	MA165TA5	DIODE
D604	MA165TA5	DIODE
D609	1SR124-4AT82	DIODE
D617	MA3068MTX	DIODE
D620	MA165TA5	DIODE
D701	MA165TA5	DIODE
D702	MTZJT-775.1C	DIODE
D704	MA29TA5	DIODE
D705	MTZJT776.2B	DIODE
D706	MA165TA5	DIODE
D707	AU02V0	DIODE
D708	MA165TA5	DIODE
D709	MTZJT-778.2C	DIODE
D710	MTZJT-7716C	DIODE
D801	RBV-608LF-B	DIODE
D803	1SR124-4AT82	DIODE
D804	1SR124-4AT82	DIODE
D805	TLP621GR-LF2	PHOTO COUPLER
D806	1SR124-4AT82	DIODE
D850	RU4BLF-L1	DIODE
D851	MTZJT776.2B	DIODE
D852	MA165TA5	DIODE
D853	MA2180BLFS	DIODE
D854	TVSRU3AMLFA5	DIODE
D855	D10SC6MRL	DIODE
D856	RU4AMLF-M1	DIODE
D857	MTZJT-775.1A	DIODE
D858	MA165TA5	DIODE
D859	MA165TA5	DIODE
D860	MA165TA5	DIODE
D861	MA165TA5	DIODE
D862	MTZJT-7736A	DIODE
D863	MA165TA5	DIODE
D864	MA165TA5	DIODE
D865	MA165TA5	DIODE
D866	MA165TA5	DIODE
D867	EK06-V0	DIODE
D868	1N4150T-77	DIODE
D869	1N4150T-77	DIODE
D870	MA165TA5	DIODE
D871	1N4150T-77	DIODE
D873	MTZJT-775.6C	DIODE
D874	1SR124-4AT82	DIODE
D875	BZX79A75A26A	DIODE
D890	MA165TA5	DIODE
D891	MA165TA5	DIODE
D901	1SS254T-77	DIODE
D902	1SS254T-77	DIODE
D903	1SS254T-77	DIODE
D910	R2KNLFA1	DIODE
D1071	SLR56UR3FS	LED
D1072	MTZJT-778.2C	DIODE
D1101	MA165TA5	DIODE
D1131	MTZJT-775.6C	DIODE
D2101	MA723TA5	DIODE
D2102	MA723TA5	DIODE
D2103	MA723TA5	DIODE
D2104	MA723TA5	DIODE
D2105	MTZJT-778.2C	DIODE
D2303	MA723TA5	DIODE

Cct Ref	Parts Number	Description
D2304	MA723TA5	DIODE
D3101	MTZJT-778.2C	DIODE
D3102	MTZJT-778.2C	DIODE
D3351	1SS254T-77	DIODE
D3352	MA165TA5	DIODE
D3353	MA165TA5	DIODE
D3354	MA165TA5	DIODE
TRANSISTORS		
Q101	BC847B	TRANSISTOR
Q102	BC847B	TRANSISTOR
Q103	BC847B	TRANSISTOR
Q104	BC847B	TRANSISTOR
Q105	BC847B	TRANSISTOR
Q251	2SD1328STX	TRANSISTOR
Q252	2SD1328STX	TRANSISTOR
Q253	BC847B	TRANSISTOR
Q254	BC847B	TRANSISTOR
Q351	2SA1767	TRANSISTOR
Q361	2SA1767	TRANSISTOR
Q371	2SA1767	TRANSISTOR
Q451	BC857B	TRANSISTOR
Q503	2SK2962TPE6	TRANSISTOR
Q551	2SC5144LB228	TRANSISTOR
Q552	2SC1473-RN	TRANSISTOR
Q601	BC847B	TRANSISTOR
Q701	BC857B	TRANSISTOR
Q702	BC847B	TRANSISTOR
Q703	IRF644R-M3S	TRANSISTOR
Q850	2SD2396K-M3	TRANSISTOR
Q851	BC857B	TRANSISTOR
Q852	2SD1858TV2	TRANSISTOR
Q853	BC847B	TRANSISTOR
Q854	BC847B	TRANSISTOR
Q855	BC847B	TRANSISTOR
Q856	BC847B	TRANSISTOR
Q857	2SA1018QTA	TRANSISTOR
Q905	BC847B	TRANSISTOR
Q906	BC847B	TRANSISTOR
Q907	BC857B	TRANSISTOR
Q908	2SA1535ARLB	TRANSISTOR
Q909	2SC3944ARLB	TRANSISTOR
Q1051	BC847B	TRANSISTOR
Q1052	BC847B	TRANSISTOR
Q1104	BC847B	TRANSISTOR
Q1105	BC847B	TRANSISTOR
Q1106	BC847B	TRANSISTOR
Q1107	BC847B	TRANSISTOR
Q1108	BC847B	TRANSISTOR
Q1501	BC847B	TRANSISTOR
Q1502	BC857B	TRANSISTOR
Q1503	BC847B	TRANSISTOR
Q1504	BC847B	TRANSISTOR
Q1505	BC857B	TRANSISTOR
Q1506	BC847B	TRANSISTOR
Q1507	BC847B	TRANSISTOR
Q1508	BC857B	TRANSISTOR
Q1509	BC847B	TRANSISTOR
Q1510	BC847B	TRANSISTOR
Q1511	BC857B	TRANSISTOR
Q1512	BC847B	TRANSISTOR
Q1513	BC847B	TRANSISTOR
Q2101	BC857B	TRANSISTOR
Q2102	BC857B	TRANSISTOR
Q2103	BC857B	TRANSISTOR
Q2301	BC847B	TRANSISTOR
Q2302	BC857B	TRANSISTOR

Cct Ref	Parts Number	Description
Q2303	BC847B	TRANSISTOR
Q2304	BC857B	TRANSISTOR
Q3006	BC847B	TRANSISTOR
Q3007	BC847B	TRANSISTOR
Q3352	BC857B	TRANSISTOR
TRANSFORMERS		
T501	ETH19Y193AY	TRANSFORMER
T801	ETS42AE296AD	TRANSFORMER
T802	ETP35KAN619U	TRANSFORMER
COILS		
J26	EXCELD35V	COIL
J212	EXCELSA35V	COIL
L101	TLT100K991R	COIL
L102	TLT068K991R	COIL
L103	EXCELSA35B	COIL
L104	TLTACT4R7K	COIL
L105	TLTACTR47K	COIL
L106	TLTACT100K	COIL
L107	TLTACT6R8K	COIL
L114	ELJFC2R2KF	COIL
L115	ELJFC2R2KF	COIL
L301	TLTACT4R7K	COIL
L353	TLT150K991R	COIL
L363	TLT100K991R	COIL
L373	TLT150K991R	COIL
L381	TLT220K991R	COIL
L451	EXCELSA35T	COIL
L501	EXCELSA35T	COIL
L581	ELHKLB026B	COIL
L582	ELC18B271E	COIL
L583	ELC18B150L	COIL
L584	ELHKLB025B	COIL
L586	EXCELD35V	COIL
L606	ELESN100KA	COIL
L701	ELC18B271E	COIL
L704	ELC10D332E	COIL
L705	EXCELD35V	COIL
L850	EXCELSA35T	COIL
L851	EXCELSA35T	COIL
L852	ELEIE470KA	COIL
L855	EXCELSA35T	COIL
L856	EXCELSA39V	COIL
L910	EXCELSA35T	COIL
L911	EXCELSA35T	COIL
L912	EXCELSA35T	COIL
L1103	TLTACT100K	COIL
L1104	EXCELSA35T	COIL
L1105	ELJFC2R2KF	COIL
L1501	ELESN2R2KA	COIL
L1502	ELESN2R2KA	COIL
L1503	ELESN2R2KA	COIL
L1504	ELESN2R2KA	COIL
L1505	ELESN100KA	COIL
L1506	ELESN100KA	COIL
L1507	ELESNR22KA	COIL
L1508	ELESNR22KA	COIL
L1509	ELESN100KA	COIL
L1510	ELESN100KA	COIL
L1514	ELESN100KA	COIL
L1515	ELESNR39KA	COIL
L1516	ELESN4R7KA	COIL
L1517	ELESN4R7KA	COIL
L1518	ELESN4R7KA	COIL
L1519	ELESNR39KA	COIL
L1520	ELESN2R2KA	COIL
L1521	ELESN1R0KA	COIL

Cct Ref	Parts Number	Description
L1522	ELESN2R2KA	COIL
L1523	ELESN2R2KA	COIL
L1524	ELESN2R2KA	COIL
L1525	ELESN100KA	COIL
L1526	ELESN100KA	COIL
L1527	ELESN100KA	COIL
L1528	ELESN100KA	COIL
L1529	ELESN100KA	COIL
L1530	EXCELD35V	COIL
L2101	TLTACT100K	COIL
L2103	EXCELSA35T	COIL
L2104	TLTACT4R7K	COIL
L3001	ELEMV1R5MA	COIL
L3002	ELEMV1R5MA	COIL
L3003	ELEMV1R5MA	COIL
L3004	ELEMV1R5MA	COIL
L3101	ELEBT6R8KA	COIL
L3102	ELEBT6R8KA	COIL
FILTERS		
L802	ELF18N012A	LINE FILTER
L804	ELF18N012A	LINE FILTER
X101	EFCT6504BF	FILTER
X102	EFCT7004BF	CERAMIC FILTER
CRYSTALS		
X1101	TSSA121	CRYSTAL
X1501	4730007267	CRYSTAL
X1502	4730007341	CRYSTAL
X2101	4730007158	CRYSTAL
RESISTORS		
C510	ERJ6GEY0R00	S.M.CARB 0.1W 5% 0 Ω
JA1	ERJ6GEY0R00	S.M.CARB 0.1W 5% 0 Ω
JA2	ERJ6GEY0R00	S.M.CARB 0.1W 5% 0 Ω
JA3	ERJ6GEY0R00	S.M.CARB 0.1W 5% 0 Ω
JA4	ERJ6GEY0R00	S.M.CARB 0.1W 5% 0 Ω
JA5	ERJ6GEY0R00	S.M.CARB 0.1W 5% 0 Ω
JA6	ERJ6GEY0R00	S.M.CARB 0.1W 5% 0 Ω
JA7	ERJ6GEY0R00	S.M.CARB 0.1W 5% 0 Ω
JA8	ERJ6GEY0R00	S.M.CARB 0.1W 5% 0 Ω
JA9	ERJ6GEY0R00	S.M.CARB 0.1W 5% 0 Ω
JA10	ERJ6GEY0R00	S.M.CARB 0.1W 5% 0 Ω
JA12	ERJ6GEY0R00	S.M.CARB 0.1W 5% 0 Ω
JA13	ERJ6GEY0R00	S.M.CARB 0.1W 5% 0 Ω
JA14	ERJ6GEY0R00	S.M.CARB 0.1W 5% 0 Ω
JA15	ERJ6GEY0R00	S.M.CARB 0.1W 5% 0 Ω
JA16	ERJ6GEY0R00	S.M.CARB 0.1W 5% 0 Ω
JA17	ERJ6GEY0R00	S.M.CARB 0.1W 5% 0 Ω
JA18	ERJ6GEY0R00	S.M.CARB 0.1W 5% 0 Ω
JA19	ERJ6GEY0R00	S.M.CARB 0.1W 5% 0 Ω
JA20	ERJ6GEY0R00	S.M.CARB 0.1W 5% 0 Ω
JA101	ERJ8GEY0R00	S.M.CARB .125W 5% 0 Ω
JA102	ERJ8GEY0R00	S.M.CARB .125W 5% 0 Ω
JA103	ERJ8GEY0R00	S.M.CARB .125W 5% 0 Ω
JA104	ERJ8GEY0R00	S.M.CARB .125W 5% 0 Ω
JA105	ERJ8GEY0R00	S.M.CARB .125W 5% 0 Ω
JA106	ERJ8GEY0R00	S.M.CARB .125W 5% 0 Ω
JA107	ERJ8GEY0R00	S.M.CARB .125W 5% 0 Ω
JA108	ERJ8GEY0R00	S.M.CARB .125W 5% 0 Ω
JA109	ERJ8GEY0R00	S.M.CARB .125W 5% 0 Ω
JA110	ERJ8GEY0R00	S.M.CARB .125W 5% 0 Ω
JA111	ERJ8GEY0R00	S.M.CARB .125W 5% 0 Ω
JA112	ERJ8GEY0R00	S.M.CARB .125W 5% 0 Ω
JA113	ERJ8GEY0R00	S.M.CARB .125W 5% 0 Ω
JA114	ERJ8GEY0R00	S.M.CARB .125W 5% 0 Ω
JA115	ERJ8GEY0R00	S.M.CARB .125W 5% 0 Ω
JA116	ERJ8GEY0R00	S.M.CARB .125W 5% 0 Ω

Cct Ref	Parts Number	Description			
JA117	ERJ8GEY0R00	S.M.CARB	.125W	5%	0 Ω
JA118	ERJ8GEY0R00	S.M.CARB	.125W	5%	0 Ω
JA119	ERJ8GEY0R00	S.M.CARB	.125W	5%	0 Ω
JA200	ERJ8GEY0R00	S.M.CARB	.125W	5%	0 Ω
JA201	ERJ6GEY0R00	S.M.CARB	0.1W	5%	0 Ω
JA202	ERJ6GEY0R00	S.M.CARB	0.1W	5%	0 Ω
JSE3	ERJ6GEY0R00	S.M.CARB	0.1W	5%	0 Ω
JSE4	ERJ6GEY0R00	S.M.CARB	0.1W	5%	0 Ω
JSE5	ERJ6GEY0R00	S.M.CARB	0.1W	5%	0 Ω
JSE6	ERJ6GEY0R00	S.M.CARB	0.1W	5%	0 Ω
JSE10	ERJ6GEY0R00	S.M.CARB	0.1W	5%	0 Ω
JSE12	ERJ6GEY0R00	S.M.CARB	0.1W	5%	0 Ω
JSE13	ERJ6GEY0R00	S.M.CARB	0.1W	5%	0 Ω
JSE18	ERJ6GEY0R00	S.M.CARB	0.1W	5%	0 Ω
JSE26	ERJ6GEY0R00	S.M.CARB	0.1W	5%	0 Ω
JSE33	ERJ6GEY0R00	S.M.CARB	0.1W	5%	0 Ω
JSE35	ERJ6GEY0R00	S.M.CARB	0.1W	5%	0 Ω
JSE42	ERJ6GEY0R00	S.M.CARB	0.1W	5%	0 Ω
JSE43	ERJ6GEY0R00	S.M.CARB	0.1W	5%	0 Ω
JSE45	ERJ8GEY0R00	S.M.CARB	.125W	5%	0 Ω
JSE46	ERJ8GEY0R00	S.M.CARB	.125W	5%	0 Ω
JSE47	ERJ8GEY0R00	S.M.CARB	.125W	5%	0 Ω
JSF1	ERJ8GEY0R00	S.M.CARB	.125W	5%	0 Ω
JSF2	ERJ8GEY0R00	S.M.CARB	.125W	5%	0 Ω
JSF3	ERJ8GEY0R00	S.M.CARB	.125W	5%	0 Ω
JSY04	ERJ6GEY0R00	S.M.CARB	0.1W	5%	0 Ω
Q1101	ERD25TC0T	CARBON	0.25W	5%	0 Ω
R101	ERJ6GEYJ331	S.M.CARB	0.1W	5%	330 Ω
R102	ERJ6GEYJ103	S.M.CARB	0.1W	5%	10K Ω
R103	ERJ6GEYJ102	S.M.CARB	0.1W	5%	1K Ω
R104	ERJ6GEYJ331	S.M.CARB	0.1W	5%	330 Ω
R105	ERJ6GEYJ101	S.M.CARB	0.1W	5%	100 Ω
R106	ERJ6GEYJ680	S.M.CARB	0.1W	5%	68 Ω
R107	ERJ6GEYJ102	S.M.CARB	0.1W	5%	1K Ω
R108	ERJ6GEYJ103	S.M.CARB	0.1W	5%	10K Ω
R109	ERJ6GEYJ103	S.M.CARB	0.1W	5%	10K Ω
R110	ERJ6GEYJ471	S.M.CARB	0.1W	5%	470 Ω
R111	ERJ6GEYJ393	S.M.CARB	0.1W	5%	39K Ω
R112	ERJ6GEYJ101	S.M.CARB	0.1W	5%	100 Ω
R113	ERJ6GEYJ223	S.M.CARB	0.1W	5%	22K Ω
R116	ERJ6GEYJ562	S.M.CARB	0.1W	5%	5K6 Ω
R117	ERJ6GEYJ222	S.M.CARB	0.1W	5%	2K2 Ω
R118	ERJ6GEYJ102	S.M.CARB	0.1W	5%	1K Ω
R121	ERJ6GEYJ471	S.M.CARB	0.1W	5%	470 Ω
R251	ERJ6GEYJ101	S.M.CARB	0.1W	5%	100 Ω
R252	ERJ6GEYJ272	S.M.CARB	0.1W	5%	2K7 Ω
R253	ERJ6GEYJ103	S.M.CARB	0.1W	5%	10K Ω
R254	ERJ6GEYJ101	S.M.CARB	0.1W	5%	100 Ω
R255	ERJ6GEYJ103	S.M.CARB	0.1W	5%	10K Ω
R256	ERJ6GEYJ471	S.M.CARB	0.1W	5%	470 Ω
R257	ERJ6GEYJ470	S.M.CARB	0.1W	5%	47 Ω
R258	ERJ6GEYJ272	S.M.CARB	0.1W	5%	2K7 Ω
R259	ERJ6GEYJ470	S.M.CARB	0.1W	5%	47 Ω
R260	ERJ6GEYJ103	S.M.CARB	0.1W	5%	10K Ω
R261	ERJ6GEYJ471	S.M.CARB	0.1W	5%	470 Ω
R262	ERJ6GEYJ103	S.M.CARB	0.1W	5%	10K Ω
R263	ERJ6GEYJ473	S.M.CARB	0.1W	5%	47K Ω
R264	ERJ6GEYJ103	S.M.CARB	0.1W	5%	10K Ω
R265	ERD25TJ2R2	CARBON	0.25W	5%	2R2 Ω
R266	ERD25TJ2R2	CARBON	0.25W	5%	2R2 Ω
R267	ERF7ZK4R7	WOUND	7W	10%	4R7 Ω ▲
R268	ERJ6GEYJ103	S.M.CARB	0.1W	5%	10K Ω
R269	ERQ14AJ101	METAL	0.25W	5%	100 Ω ▲
R271	ERJ6GEYJ103	S.M.CARB	0.1W	5%	10K Ω
R272	ERF7ZK4R7	WOUND	7W	10%	4R7 Ω ▲
R350	ERQ12AJ151P	FUSIBLE	0.5W	5%	150 Ω ▲

Cct Ref	Parts Number	Description			
R352	ERJ6GEYJ202	S.M.CARB	0.1W	5%	2K Ω
R355	ERG1ANJ683	METAL	1W	5%	68K Ω
R356	ERJ6GEYJ181	S.M.CARB	0.1W	5%	180 Ω
R357	ERJ6GEYJ822	S.M.CARB	0.1W	5%	8K2 Ω
R358	ERDS1TJ821	CARBON	0.5W	5%	820 Ω
R359	ERD25TC0T	CARBON	0.25W	5%	0 Ω
R360	ERO50PKF8251	METAL	0.5W	5%	8M2 Ω ▲
R362	ERJ6GEYJ202	S.M.CARB	0.1W	5%	2K Ω
R365	ERG1ANJ683	METAL	1W	5%	68K Ω
R366	ERJ6GEYJ181	S.M.CARB	0.1W	5%	180 Ω
R367	ERJ6GEYJ822	S.M.CARB	0.1W	5%	8K2 Ω
R368	ERDS1TJ821	CARBON	0.5W	5%	820 Ω
R369	ERD25TC0T	CARBON	0.25W	5%	0 Ω
R372	ERJ6GEYJ202	S.M.CARB	0.1W	5%	2K Ω
R375	ERG1ANJ683	METAL	1W	5%	68K Ω
R376	ERJ6GEYJ181	S.M.CARB	0.1W	5%	180 Ω
R377	ERJ6GEYJ822	S.M.CARB	0.1W	5%	8K2 Ω
R378	ERDS1TJ821	CARBON	0.5W	5%	820 Ω
R379	ERD25TC0T	CARBON	0.25W	5%	0 Ω
R385	ERQ12HJ1R2	METAL	0.5W	5%	1R2 Ω ▲
R394	ERJ6GEYJ821	S.M.CARB	0.1W	5%	820 Ω
R396	ERJ6GEYJ821	S.M.CARB	0.1W	5%	820 Ω
R398	ERJ6GEYJ821	S.M.CARB	0.1W	5%	820 Ω
R451	ERJ6GEYJ223	S.M.CARB	0.1W	5%	22K Ω
R452	ERJ6GEY0R00	S.M.CARB	0.1W	5%	0 Ω
R453	ERJ6GEY0R00	S.M.CARB	0.1W	5%	0 Ω
R454	ERJ6GEYJ393	S.M.CARB	0.1W	5%	39K Ω
R455	ERJ6GEYJ223	S.M.CARB	0.1W	5%	22K Ω
R456	ERJ6GEYJ104	S.M.CARB	0.1W	5%	100K Ω
R457	ERJ6GEYJ223	S.M.CARB	0.1W	5%	22K Ω
R458	ERDS1TJ1R0	CARBON	0.5W	5%	1 Ω
R459	ERJ6GEYJ101	S.M.CARB	0.1W	5%	100 Ω
R460	ERG3SJS151	METAL	3W	5%	150 Ω
R461	ERX2SJS1R2H	FUSIBLE	2W	5%	1R2 Ω
R463	ERD25TJ222	CARBON	0.25W	5%	2K2 Ω
R464	ERJ6GEYJ682	S.M.CARB	0.1W	5%	6K8 Ω
R465	ERJ6GEYJ102	S.M.CARB	0.1W	5%	1K Ω
R467	ERJ6GEY0R00	S.M.CARB	0.1W	5%	0 Ω
R502	ERJ6GEYJ511	S.M.CARB	0.1W	5%	510 Ω
R503	ERJ6GEYJ105	S.M.CARB	0.1W	5%	1M Ω
R507	ERG2ANJ330	METAL	2W	5%	33 Ω
R509	ERG1SJ222E	METAL	0.5W	5%	2K2 Ω
R510	ERG1SJ222E	METAL	0.5W	5%	2K2 Ω
R551	ERX3SJSR33	METAL	3W	5%	R33 Ω
R555	ERQ12HKR82	FUSIBLE	0.5W	10%	R82 Ω ▲
R558	ERDS1TJ124	CARBON	0.5W	5%	120K Ω
R559	ERQ12HKR82	FUSIBLE	0.5W	10%	R82 Ω ▲
R560	ERJ6GEYJ274	S.M.CARB	0.1W	5%	270K Ω
R561	ERJ6GEYJ223	S.M.CARB	0.1W	5%	22K Ω
R563	ERJ6GEYJ824	S.M.CARB	0.1W	5%	820K Ω
R564	ERJ6GEYJ563	S.M.CARB	0.1W	5%	56K Ω
R566	ERJ6GEYJ563	S.M.CARB	0.1W	5%	56K Ω
R567	ERF7ZK1R0	WOUND	7W	10%	1 Ω ▲
R568	ERDS1TJ120	CARBON	0.5W	5%	12 Ω
R581	ERQ2CJP821	METAL	2W	5%	820 Ω ▲
R582	ERG3FJ471	METAL	3W	5%	470 Ω ▲
R583	ERG3FJ331	METAL	3W	5%	330 Ω ▲
R603	ERJ6GEYJ223	S.M.CARB	0.1W	5%	22K Ω
R604	ERJ6GEYJ101	S.M.CARB	0.1W	5%	100 Ω
R605	ERJ6GEYJ101	S.M.CARB	0.1W	5%	100 Ω
R606	ERJ6GEYJ472	S.M.CARB	0.1W	5%	4K7 Ω
R607	ERJ6GEY0R00	S.M.CARB	0.1W	5%	0 Ω
R608	ERJ6GEYJ201	S.M.CARB	0.1W	5%	200 Ω
R609	ERJ6GEYJ201	S.M.CARB	0.1W	5%	200 Ω
R610	ERJ6GEYJ242	S.M.CARB	0.1W	5%	2K4 Ω
R611	ERJ6GEYJ104	S.M.CARB	0.1W	5%	100K Ω

Cct Ref	Parts Number	Description				
R612	ERJ6GEYJ101	S.M.CARB	0.1W	5%	100 Ω	
R620	ERJ6GEYJ103	S.M.CARB	0.1W	5%	10K Ω	
R622	ERJ6GEY0R00	S.M.CARB	0.1W	5%	0 Ω	
R647	ERJ6GEYJ101	S.M.CARB	0.1W	5%	100 Ω	
R648	ERJ6GEYJ332	S.M.CARB	0.1W	5%	3K3 Ω	
R650	ERJ6GEYJ750	S.M.CARB	0.1W	5%	75 Ω	
R701	ERQ12AJ330P	METAL	0.5W	5%	330 Ω	△
R702	ERX2SJ2R7	FUSIBLE	2W	5%	2R7 Ω	
R703	ERG2FJ821	METAL	2W	5%	820 Ω	△
R704	ERJ6GEYJ563	S.M.CARB	0.1W	5%	56K Ω	
R705	ERJ6GEYJ473	S.M.CARB	0.1W	5%	47K Ω	
R706	ERJ6GEYJ103	S.M.CARB	0.1W	5%	10K Ω	
R707	ERJ6GEYJ391	S.M.CARB	0.1W	5%	390 Ω	
R708	ERJ6GEYJ393	S.M.CARB	0.1W	5%	39K Ω	
R709	ERJ6GEYJ393	S.M.CARB	0.1W	5%	39K Ω	
R710	ERJ6GEYJ273	S.M.CARB	0.1W	5%	27K Ω	
R711	ERG1SJ101	METAL	1W	5%	100 Ω	
R712	ERJ6GEYJ102	S.M.CARB	0.1W	5%	1K Ω	
R714	ERJ6GEYJ222	S.M.CARB	0.1W	5%	2K2 Ω	
R715	ERD25TJ272	CARBON	0.25W	5%	2K7 Ω	
R716	ERQ12AJ680P	METAL	0.5W	5%	68 Ω	△
R718	ERJ6GEYJ102	S.M.CARB	0.1W	5%	1K Ω	
R719	ERJ6GEYJ224	S.M.CARB	0.1W	5%	220K Ω	
R720	ERJ6GEYJ105	S.M.CARB	0.1W	5%	1M Ω	
R721	ERJ6GEYJ563	S.M.CARB	0.1W	5%	56K Ω	
R801	ERC12ZGK335D	SOLID	0.5W	10%	3M3 Ω	
R805	ERD25TJ473	CARBON	0.25W	5%	47K Ω	
R806	ERD25TJ100	CARBON	0.25W	5%	10 Ω	
R807	ERD25TJ332	CARBON	0.25W	5%	3K3 Ω	
R809	ERD25TJ681	CARBON	0.25W	5%	680 Ω	
R810	ERW2PKR27	WOUND	2W	10%	R27 Ω	△
R811	ERW2PKR27	WOUND	2W	10%	R27 Ω	△
R812	ERD75TAJ825	CARBON	0.75W	5%	8M2 Ω	△
R813	ERF7ZK2R7	WOUND	7W	20%	2R7 Ω	△
R814	ERD25TJ473	CARBON	0.25W	5%	47K Ω	
R815	ERD25TJ222	CARBON	0.25W	5%	2K2 Ω	
R850	ERD25TJ122	CARBON	0.25W	5%	1K2 Ω	
R852	ERJ6GEY0R00	S.M.CARB	0.1W	5%	0 Ω	
R853	ERJ6GEYJ681	S.M.CARB	0.1W	5%	680 Ω	
R854	ERG2FJ223	METAL	2W	5%	22K Ω	△
R855	ERJ6GEYJ752	S.M.CARB	0.1W	5%	7K5 Ω	
R856	ERJ6GEYJ752	S.M.CARB	0.1W	5%	7K5 Ω	
R857	ERJ6GEYJ752	S.M.CARB	0.1W	5%	7K5 Ω	
R858	ERJ6GEYJ752	S.M.CARB	0.1W	5%	7K5 Ω	
R859	ERJ6GEYJ753	S.M.CARB	0.1W	5%	75K Ω	
R860	ERQ1CJP2R2	FUSIBLE	1W	10%	2R2 Ω	△
R861	ERD25TJ221	CARBON	0.25W	5%	220 Ω	
R862	ERD25TJ272	CARBON	0.25W	5%	2K7 Ω	
R863	ERDS1TJ560	CARBON	0.5W	5%	56 Ω	
R864	ERDS1TJ151	CARBON	0.5W	5%	150 Ω	
R865	ERJ6GEY0R00	S.M.CARB	0.1W	5%	0 Ω	
R867	ERJ6GEYJ103	S.M.CARB	0.1W	5%	10K Ω	
R868	ERJ6GEYJ223	S.M.CARB	0.1W	5%	22K Ω	
R869	ERJ6GEY0R00	S.M.CARB	0.1W	5%	0 Ω	
R870	ERJ6GEYJ272	S.M.CARB	0.1W	5%	2K7 Ω	
R871	ERJ6GEYJ153	S.M.CARB	0.1W	5%	15K Ω	
R872	ERG1SJ183	METAL	1W	5%	18K Ω	
R873	ERG1SJ223	METAL	1W	5%	22K Ω	
R874	ERD25TJ104	CARBON	0.25W	5%	100K Ω	
R876	ERJ6GEYJ103	S.M.CARB	0.1W	5%	10K Ω	
R877	ERW2PKR47	WOUND	2W	10%	R47 Ω	△
R878	ERJ6GEYJ473	S.M.CARB	0.1W	5%	47K Ω	
R879	ERG3FJ680H	METAL	3W	5%	68 Ω	△
R880	ERG5FJ120H	METAL	5W	5%	12 Ω	△
R882	ERG2FJ330H	METAL	2W	5%	33 Ω	△
R890	ERX1FJ3R9P	FUSIBLE	1W	5%	3R9 Ω	△

Cct Ref	Parts Number	Description				
R913	ERJ6GEYJ183	S.M.CARB	0.1W	5%	18K Ω	
R914	ERJ6GEYJ222	S.M.CARB	0.1W	5%	2K2 Ω	
R915	ERJ6GEYJ182	S.M.CARB	0.1W	5%	1K8 Ω	
R916	ERJ6GEYJ221	S.M.CARB	0.1W	5%	220 Ω	
R917	ERJ6GEYJ121	S.M.CARB	0.1W	5%	120 Ω	
R918	ERJ6GEY0R00	S.M.CARB	0.1W	5%	0 Ω	
R919	ERQ14AJW390	FUSIBLE	0.25W	5%	39 Ω	△
R920	ERQ14AJW390	FUSIBLE	0.25W	5%	39 Ω	△
R922	ERD25TJ683	CARBON	0.25W	5%	68K Ω	
R923	ERD25TJ683	CARBON	0.25W	5%	68K Ω	
R924	ERDS1FYJ390	CARBON	0.5W	5%	39 Ω	△
R925	ERJ6GEY0R00	S.M.CARB	0.1W	5%	0 Ω	
R926	ERJ6GEY0R00	S.M.CARB	0.1W	5%	0 Ω	
R927	ERD25TJ122	CARBON	0.25W	5%	1K2 Ω	
R928	ERD25TJ5R6	CARBON	0.25W	5%	5R6 Ω	
R929	ERDS1FVJ471	RESISTOR	0.5W	5%	470 Ω	△
R931	ERDS1FYJ390	CARBON	0.5W	5%	39 Ω	△
R935	ERQ14AJW3R9	FUSIBLE	0.25W	5%	3R9 Ω	△
R936	ERQ1CJP102	FUSIBLE	1W	5%	1K Ω	△
R937	ERQ14AJW100	FUSIBLE	0.25W	5%	10 Ω	△
R938	ERD25TJ122	CARBON	0.25W	5%	1K2 Ω	
R941	ERD25TJ5R6	CARBON	0.25W	5%	5R6 Ω	
R1051	ERJ6GEYJ102	S.M.CARB	0.1W	5%	1K Ω	
R1052	ERJ6GEYJ471	S.M.CARB	0.1W	5%	470 Ω	
R1053	ERJ6GEYJ103	S.M.CARB	0.1W	5%	10K Ω	
R1054	ERJ6GEY0R00	S.M.CARB	0.1W	5%	0 Ω	
R1071	ERJ6GEYJ750	S.M.CARB	0.1W	5%	75 Ω	
R1101	ERJ6GEYJ101	S.M.CARB	0.1W	5%	100 Ω	
R1102	ERJ6GEYJ102	S.M.CARB	0.1W	5%	1K Ω	
R1103	ERJ6GEYJ331	S.M.CARB	0.1W	5%	330 Ω	
R1104	ERJ6GEYJ331	S.M.CARB	0.1W	5%	330 Ω	
R1105	ERJ6GEYJ101	S.M.CARB	0.1W	5%	100 Ω	
R1106	ERJ6GEYJ104	S.M.CARB	0.1W	5%	100K Ω	
R1107	ERJ6GEYJ104	S.M.CARB	0.1W	5%	100K Ω	
R1108	ERJ6GEYJ102	S.M.CARB	0.1W	5%	1K Ω	
R1109	ERJ6GEYJ472	S.M.CARB	0.1W	5%	4K7 Ω	
R1110	ERJ6GEYJ472	S.M.CARB	0.1W	5%	4K7 Ω	
R1111	ERJ6GEYJ103	S.M.CARB	0.1W	5%	10K Ω	
R1112	ERJ6GEYJ473	S.M.CARB	0.1W	5%	47K Ω	
R1113	ERJ6GEYJ101	S.M.CARB	0.1W	5%	100 Ω	
R1115	ERJ6GEYJ471	S.M.CARB	0.1W	5%	470 Ω	
R1116	ERJ6GEYJ101	S.M.CARB	0.1W	5%	100 Ω	
R1117	ERJ6GEYJ101	S.M.CARB	0.1W	5%	100 Ω	
R1118	ERJ6GEYJ472	S.M.CARB	0.1W	5%	4K7 Ω	
R1119	ERJ6GEYJ472	S.M.CARB	0.1W	5%	4K7 Ω	
R1120	ERJ6GEYJ101	S.M.CARB	0.1W	5%	100 Ω	
R1121	ERJ6GEYJ101	S.M.CARB	0.1W	5%	100 Ω	
R1123	ERJ6GEYJ101	S.M.CARB	0.1W	5%	100 Ω	
R1125	ERJ6GEYJ472	S.M.CARB	0.1W	5%	4K7 Ω	
R1126	ERJ6GEYJ101	S.M.CARB	0.1W	5%	100 Ω	
R1127	ERJ6GEYJ101	S.M.CARB	0.1W	5%	100 Ω	
R1128	ERJ6GEYJ682	S.M.CARB	0.1W	5%	6K8 Ω	
R1129	ERJ6GEYJ682	S.M.CARB	0.1W	5%	6K8 Ω	
R1130	ERJ6GEYJ103	S.M.CARB	0.1W	5%	10K Ω	
R1131	ERJ6GEYJ103	S.M.CARB	0.1W	5%	10K Ω	
R1132	ERJ6GEYJ101	S.M.CARB	0.1W	5%	100 Ω	
R1133	ERJ6GEYJ272	S.M.CARB	0.1W	5%	2K7 Ω	
R1136	ERJ6GEYJ273	S.M.CARB	0.1W	5%	27K Ω	
R1137	ERJ6GEY0R00	S.M.CARB	0.1W	5%	0 Ω	
R1138	ERJ6GEYJ105	S.M.CARB	0.1W	5%	1M Ω	
R1139	ERJ6GEYJ471	S.M.CARB	0.1W	5%	470 Ω	
R1140	ERJ6GEYJ471	S.M.CARB	0.1W	5%	470 Ω	
R1141	ERJ6GEYJ471	S.M.CARB	0.1W	5%	470 Ω	
R1142	ERJ6GEYJ472	S.M.CARB	0.1W	5%	4K7 Ω	
R1145	ERJ6GEYJ101	S.M.CARB	0.1W	5%	100 Ω	
R1146	ERJ6GEYJ101	S.M.CARB	0.1W	5%	100 Ω	

Cct Ref	Parts Number	Description			
R1147	ERJ6GEYJ101	S.M.CARB	0.1W	5%	100 Ω
R1148	ERJ6GEYJ101	S.M.CARB	0.1W	5%	100 Ω
R1149	ERJ6GEYJ223	S.M.CARB	0.1W	5%	22K Ω
R1151	ERJ6GEYJ101	S.M.CARB	0.1W	5%	100 Ω
R1152	ERJ6GEYJ101	S.M.CARB	0.1W	5%	100 Ω
R1154	ERJ6GEYJ101	S.M.CARB	0.1W	5%	100 Ω
R1155	ERJ6GEYJ101	S.M.CARB	0.1W	5%	100 Ω
R1156	ERJ6GEYJ101	S.M.CARB	0.1W	5%	100 Ω
R1157	ERJ6GEYJ103	S.M.CARB	0.1W	5%	10K Ω
R1158	ERJ6GEYJ101	S.M.CARB	0.1W	5%	100 Ω
R1159	ERJ6GEY0R00	S.M.CARB	0.1W	5%	0 Ω
R1160	ERJ6GEYJ223	S.M.CARB	0.1W	5%	22K Ω
R1161	ERJ6GEYJ103	S.M.CARB	0.1W	5%	10K Ω
R1162	ERJ6GEYJ222	S.M.CARB	0.1W	5%	2K2 Ω
R1163	ERJ6GEYJ222	S.M.CARB	0.1W	5%	2K2 Ω
R1164	ERJ6GEYJ332	S.M.CARB	0.1W	5%	3K3 Ω
R1165	ERJ6GEYJ512	S.M.CARB	0.1W	5%	5K1 Ω
R1166	ERJ6GEYJ912	S.M.CARB	0.1W	5%	9K1 Ω
R1167	ERJ6GEYJ100	S.M.CARB	0.1W	5%	10 Ω
R1168	ERJ6GEYJ473	S.M.CARB	0.1W	5%	47K Ω
R1169	ERJ6GEYJ472	S.M.CARB	0.1W	5%	4K7 Ω
R1170	ERJ6GEYJ273	S.M.CARB	0.1W	5%	27K Ω
R1171	ERJ6GEYJ224	S.M.CARB	0.1W	5%	220K Ω
R1172	ERJ6GEYJ223	S.M.CARB	0.1W	5%	22K Ω
R1173	ERJ6GEYJ104	S.M.CARB	0.1W	5%	100K Ω
R1174	ERJ6GEYJ221	S.M.CARB	0.1W	5%	220 Ω
R1175	ERJ6GEYJ225	S.M.CARB	0.1W	5%	2M2 Ω
R1178	ERJ6GEY0R00	S.M.CARB	0.1W	5%	0 Ω
R1501	ERJ6GEYJ101	S.M.CARB	0.1W	5%	100 Ω
R1502	ERJ6GEYJ101	S.M.CARB	0.1W	5%	100 Ω
R1504	ERJ6GEYJ750	S.M.CARB	0.1W	5%	75 Ω
R1505	ERJ6GEYJ750	S.M.CARB	0.1W	5%	75 Ω
R1506	ERJ6GEYJ750	S.M.CARB	0.1W	5%	75 Ω
R1507	ERJ6GEYJ101	S.M.CARB	0.1W	5%	100 Ω
R1508	ERJ6GEYJ750	S.M.CARB	0.1W	5%	75 Ω
R1509	ERJ6GEYJ750	S.M.CARB	0.1W	5%	75 Ω
R1510	ERJ6GEYJ750	S.M.CARB	0.1W	5%	75 Ω
R1511	ERJ6GEYJ750	S.M.CARB	0.1W	5%	75 Ω
R1512	ERJ6GEYJ750	S.M.CARB	0.1W	5%	75 Ω
R1513	ERJ6GEYJ102	S.M.CARB	0.1W	5%	1K Ω
R1514	ERJ6GEYJ472	S.M.CARB	0.1W	5%	4K7 Ω
R1515	ERJ6GEYJ752	S.M.CARB	0.1W	5%	7K5 Ω
R1517	ERJ6GEY0R00	S.M.CARB	0.1W	5%	0 Ω
R1521	ERJ6GEYJ750	S.M.CARB	0.1W	5%	75 Ω
R1522	ERJ6GEYJ391	S.M.CARB	0.1W	5%	390 Ω
R1523	ERJ6GEYJ331	S.M.CARB	0.1W	5%	330 Ω
R1524	ERJ6GEYJ102	S.M.CARB	0.1W	5%	1K Ω
R1525	ERJ6GEYJ750	S.M.CARB	0.1W	5%	75 Ω
R1526	ERJ6GEYJ391	S.M.CARB	0.1W	5%	390 Ω
R1527	ERJ6GEYJ122	S.M.CARB	0.1W	5%	1K2 Ω
R1528	ERJ6GEYJ102	S.M.CARB	0.1W	5%	1K Ω
R1529	ERJ6GEYJ122	S.M.CARB	0.1W	5%	1K2 Ω
R1530	ERJ6GEYJ750	S.M.CARB	0.1W	5%	75 Ω
R1531	ERJ6GEYJ102	S.M.CARB	0.1W	5%	1K Ω
R1532	ERJ6GEYJ391	S.M.CARB	0.1W	5%	390 Ω
R1533	ERJ6GEYJ122	S.M.CARB	0.1W	5%	1K2 Ω
R1534	ERJ6GEYJ102	S.M.CARB	0.1W	5%	1K Ω
R1535	ERJ6GEYJ750	S.M.CARB	0.1W	5%	75 Ω
R1536	ERJ6GEYJ391	S.M.CARB	0.1W	5%	390 Ω
R1537	ERJ6GEYJ682	S.M.CARB	0.1W	5%	6K8 Ω
R1538	ERJ6GEYJ331	S.M.CARB	0.1W	5%	330 Ω
R1539	ERJ6GEYJ271	S.M.CARB	0.1W	5%	270 Ω
R1540	ERJ6GEYJ682	S.M.CARB	0.1W	5%	6K8 Ω
R1541	ERJ6GEYJ103	S.M.CARB	0.1W	5%	10K Ω
R1542	ERJ6GEYJ152	S.M.CARB	0.1W	5%	1K5 Ω
R1543	ERJ6GEYJ101	S.M.CARB	0.1W	5%	100 Ω

Cct Ref	Parts Number	Description			
R1544	ERJ6GEYJ101	S.M.CARB	0.1W	5%	100 Ω
R1545	ERJ6GEYJ101	S.M.CARB	0.1W	5%	100 Ω
R1546	ERJ6GEYJ101	S.M.CARB	0.1W	5%	100 Ω
R1547	ERJ6GEYJ101	S.M.CARB	0.1W	5%	100 Ω
R1548	ERJ6GEYJ101	S.M.CARB	0.1W	5%	100 Ω
R1549	ERJ6GEYJ101	S.M.CARB	0.1W	5%	100 Ω
R1550	ERJ6GEYJ101	S.M.CARB	0.1W	5%	100 Ω
R1551	ERJ6GEYJ101	S.M.CARB	0.1W	5%	100 Ω
R1552	ERJ6GEYJ101	S.M.CARB	0.1W	5%	100 Ω
R1553	ERJ6GEYJ101	S.M.CARB	0.1W	5%	100 Ω
R1554	ERJ6GEYJ101	S.M.CARB	0.1W	5%	100 Ω
R1555	ERJ6GEYJ101	S.M.CARB	0.1W	5%	100 Ω
R1556	ERJ6GEYJ101	S.M.CARB	0.1W	5%	100 Ω
R1557	ERJ6GEYJ101	S.M.CARB	0.1W	5%	100 Ω
R1558	ERJ6GEYJ101	S.M.CARB	0.1W	5%	100 Ω
R1559	ERJ6GEYJ101	S.M.CARB	0.1W	5%	100 Ω
R1560	ERJ6GEYJ101	S.M.CARB	0.1W	5%	100 Ω
R1561	ERJ6GEYJ101	S.M.CARB	0.1W	5%	100 Ω
R1562	ERJ6GEYJ101	S.M.CARB	0.1W	5%	100 Ω
R1563	ERJ6GEYJ101	S.M.CARB	0.1W	5%	100 Ω
R1564	ERJ6GEYJ101	S.M.CARB	0.1W	5%	100 Ω
R1565	ERJ6GEYJ101	S.M.CARB	0.1W	5%	100 Ω
R1566	ERJ6GEYJ101	S.M.CARB	0.1W	5%	100 Ω
R1567	ERJ6GEYJ101	S.M.CARB	0.1W	5%	100 Ω
R1568	ERJ6GEYJ101	S.M.CARB	0.1W	5%	100 Ω
R1569	ERJ6GEYJ101	S.M.CARB	0.1W	5%	100 Ω
R1570	ERJ6GEYJ101	S.M.CARB	0.1W	5%	100 Ω
R1571	ERJ6GEYJ101	S.M.CARB	0.1W	5%	100 Ω
R1572	ERJ6GEYJ101	S.M.CARB	0.1W	5%	100 Ω
R1573	ERJ6GEYJ101	S.M.CARB	0.1W	5%	100 Ω
R1574	ERJ6GEYJ682	S.M.CARB	0.1W	5%	6K8 Ω
R1575	ERJ6GEY0R00	S.M.CARB	0.1W	5%	0 Ω
R1577	ERJ6GEYJ103	S.M.CARB	0.1W	5%	10K Ω
R1578	ERJ6GEYJ103	S.M.CARB	0.1W	5%	10K Ω
R1579	ERJ6GEYJ101	S.M.CARB	0.1W	5%	100 Ω
R1580	ERJ6GEYJ101	S.M.CARB	0.1W	5%	100 Ω
R1584	ERJ6GEYJ471	S.M.CARB	0.1W	5%	470 Ω
R1585	ERJ6GEYJ471	S.M.CARB	0.1W	5%	470 Ω
R1586	ERJ6GEYJ471	S.M.CARB	0.1W	5%	470 Ω
R2101	ERJ6GEYJ103	S.M.CARB	0.1W	5%	10K Ω
R2102	ERJ6GEYJ101	S.M.CARB	0.1W	5%	100 Ω
R2103	ERJ6GEYJ101	S.M.CARB	0.1W	5%	100 Ω
R2109	ERJ6GEYJ183	S.M.CARB	0.1W	5%	18K Ω
R2110	ERJ6GEY0R00	S.M.CARB	0.1W	5%	0 Ω
R2111	ERJ6GEYJ221	S.M.CARB	0.1W	5%	220 Ω
R2112	ERJ6GEYJ102	S.M.CARB	0.1W	5%	1K Ω
R2113	ERJ6GEYJ562	S.M.CARB	0.1W	5%	5K6 Ω
R2114	ERJ6GEYJ101	S.M.CARB	0.1W	5%	100 Ω
R2115	ERJ6GEYJ822	S.M.CARB	0.1W	5%	8K2 Ω
R2116	ERJ6GEYJ101	S.M.CARB	0.1W	5%	100 Ω
R2117	ERJ6GEYJ101	S.M.CARB	0.1W	5%	100 Ω
R2118	ERJ6GEYJ822	S.M.CARB	0.1W	5%	8K2 Ω
R2119	ERJ6GEYJ101	S.M.CARB	0.1W	5%	100 Ω
R2120	ERJ6GEYJ222	S.M.CARB	0.1W	5%	2K2 Ω
R2302	ERJ6GEYJ104	S.M.CARB	0.1W	5%	100K Ω
R2303	ERJ6GEYJ101	S.M.CARB	0.1W	5%	100 Ω
R2304	ERJ6GEYJ471	S.M.CARB	0.1W	5%	470 Ω
R2305	ERJ6GEYJ102	S.M.CARB	0.1W	5%	1K Ω
R2306	ERJ6GEYJ103	S.M.CARB	0.1W	5%	10K Ω
R2308	ERJ6GEYJ104	S.M.CARB	0.1W	5%	100K Ω
R2309	ERJ6GEYJ101	S.M.CARB	0.1W	5%	100 Ω
R2310	ERJ6GEYJ471	S.M.CARB	0.1W	5%	470 Ω
R2311	ERJ6GEYJ102	S.M.CARB	0.1W	5%	1K Ω
R2312	ERJ6GEYJ103	S.M.CARB	0.1W	5%	10K Ω
R3001	ERJ6GEYJ101	S.M.CARB	0.1W	5%	100 Ω
R3002	ERJ6GEYJ471	S.M.CARB	0.1W	5%	470 Ω

Cct Ref	Parts Number	Description			
R3003	ERJ6GEYJ101	S.M.CARB	0.1W	5%	100 Ω
R3004	ERJ6GEYJ153	S.M.CARB	0.1W	5%	15K Ω
R3005	ERJ6GEYJ101	S.M.CARB	0.1W	5%	100 Ω
R3006	ERJ6GEYJ471	S.M.CARB	0.1W	5%	470 Ω
R3007	ERJ6GEYJ101	S.M.CARB	0.1W	5%	100 Ω
R3008	ERJ6GEYJ153	S.M.CARB	0.1W	5%	15K Ω
R3010	ERD25TJ750	CARBON	0.25W	5%	75 Ω
R3013	ERJ6GEYJ101	S.M.CARB	0.1W	5%	100 Ω
R3014	ERJ6GEYJ471	S.M.CARB	0.1W	5%	470 Ω
R3015	ERJ6GEYJ101	S.M.CARB	0.1W	5%	100 Ω
R3016	ERJ6GEYJ153	S.M.CARB	0.1W	5%	15K Ω
R3017	ERJ6GEYJ101	S.M.CARB	0.1W	5%	100 Ω
R3018	ERJ6GEYJ471	S.M.CARB	0.1W	5%	470 Ω
R3019	ERJ6GEYJ101	S.M.CARB	0.1W	5%	100 Ω
R3020	ERJ6GEYJ153	S.M.CARB	0.1W	5%	15K Ω
R3021	ERJ6GEYJ750	S.M.CARB	0.1W	5%	75 Ω
R3046	ERJ6GEYJ101	S.M.CARB	0.1W	5%	100 Ω
R3047	ERJ6GEYJ101	S.M.CARB	0.1W	5%	100 Ω
R3048	ERJ6GEYJ103	S.M.CARB	0.1W	5%	10K Ω
R3049	ERJ6GEYJ101	S.M.CARB	0.1W	5%	100 Ω
R3050	ERJ6GEYJ103	S.M.CARB	0.1W	5%	10K Ω
R3057	ERJ6GEYJ750	S.M.CARB	0.1W	5%	75 Ω
R3101	ERDS1TJ151	CARBON	0.5W	5%	150 Ω
R3102	ERDS1TJ151	CARBON	0.5W	5%	150 Ω
R3103	ERG2FJ221	METAL	2W	5%	220 Ω [△]
R3104	ERG2FJ221	METAL	2W	5%	220 Ω [△]
R3105	ERJ6GEYJ101	S.M.CARB	0.1W	5%	100 Ω
R3106	ERJ6GEYJ101	S.M.CARB	0.1W	5%	100 Ω
R3107	ERJ6GEYJ153	S.M.CARB	0.1W	5%	15K Ω
R3108	ERJ6GEYJ153	S.M.CARB	0.1W	5%	15K Ω
R3354	ERJ6GEYJ102	S.M.CARB	0.1W	5%	1K Ω
R3355	ERJ6GEYJ391	S.M.CARB	0.1W	5%	390 Ω
R3356	ERJ6GEYJ681	S.M.CARB	0.1W	5%	680 Ω
R3357	ERJ6GEYJ681	S.M.CARB	0.1W	5%	680 Ω
R3358	ERJ6GEYJ681	S.M.CARB	0.1W	5%	680 Ω
R3360	ERDS1TJ471	CARBON	0.5W	5%	470 Ω
R3361	ERO50PKF1133	METAL	0.5W	5%	110K Ω [△]
R3362	ERJ6GEYJ103	S.M.CARB	0.1W	5%	10K Ω
R3363	ERJ6GEYJ103	S.M.CARB	0.1W	5%	10K Ω
R3364	ERJ6GEYJ103	S.M.CARB	0.1W	5%	10K Ω
R3601	ERJ6GEYJ101	S.M.CARB	0.1W	5%	100 Ω
R3602	ERJ6GEYJ101	S.M.CARB	0.1W	5%	100 Ω
R3603	ERJ6GEYJ101	S.M.CARB	0.1W	5%	100 Ω
RL801	TSE1885-1	RELAY			Ω
CAPACITORS					
C101	ECJ2VB1C104K	ELECT	350V		100nF
C102	ECJ2VB1C104K	ELECT	350V		100nF
C103	ECJ2VF1H104Z	ELECT	350V		100nF
C105	ECUV1H560JCX	S.M. CAP	50V		56pF
C106	ECUV1H560JCX	S.M. CAP	50V		56pF
C107	ECJ2VF1H104Z	ELECT	350V		100nF
C108	ECA1CM470GB	ELECT	16V		47μF
C109	ECUV1H102JCX	S.M. CAP	50V		1nF
C110	ECUV1H103ZFX	S.M. CAP	50V		10nF
C111	ECA1HMR33GB	ELECT	50V		0.33μF
C114	ECJ2VF1H104Z	ELECT	350V		100nF
C115	ECUV1H103ZFX	S.M. CAP	50V		10nF
C116	ECA1CM221GB	ELECT	16V		220μF
C117	ECUV1H103ZFX	S.M. CAP	50V		10nF
C118	ECJ2VF1H104Z	ELECT	350V		100nF
C119	ECA1CM221GB	ELECT	16V		220μF
C120	ECA1CM221GB	ELECT	16V		220μF
C121	ECUV1H103KBX	S.M. CAP	50V		10nF
C124	ECUV1H220JCX	S.M. CAP	50V		22pF
C125	ECUV1H100DCX	S.M. CAP	50V		10pF
C133	ECUV1H104KBX	S.M. CAP	50V		100nF

Cct Ref	Parts Number	Description			
C134	ECUV1H104KBX	S.M. CAP	50V		100nF
C135	ECJ3VB1H104K	ELECT	3.5KV		100nF
C136	ECUV1H104KBX	S.M. CAP	50V		100nF
C138	ECUV1H104KBX	S.M. CAP	50V		100nF
C251	ECA1EM330B	ELECT	25V		33μF
C252	ECUV1H472KBX	S.M. CAP	50V		4.7nF
C253	ECA1HM4R7GB	ELECT	50V		4.7μF
C254	ECQM1H684J	FILM	50V		680nF
C255	ECA1EM101GB	ELECT	25V		100μF
C256	ECUV1H472KBX	S.M. CAP	50V		4.7nF
C257	ECA1HM4R7GB	ELECT	50V		4.7μF
C258	ECA1EM330B	ELECT	25V		33μF
C259	ECQM1H684J	FILM	50V		680nF
C260	ECA1VM102GB	ELECT	35V		1nF
C261	ECA1VM102GB	ELECT	35V		1nF
C262	ECQM1H334J	FILM	50V		330nF
C263	ECA1HM010GB	ELECT	50V		1μF
C264	ECA1HHG222E	ELECT	50V		2200μF
C265	ECQM1H334J	FILM	50V		330nF
C266	ECA1HM010GB	ELECT	50V		1μF
C267	ECJ2VB1H104K	ELECT	350V		100nF
C268	ECJ2VB1H104K	ELECT	350V		100nF
C270	ECJ2VB1H104K	ELECT	350V		100nF
C352	ECUV1H224ZFX	S.M. CAP	50V		220nF
C353	ECUV1H104KBX	S.M. CAP	50V		100nF
C354	ECQM2104KZ	FILM	250V		100nF
C355	ECKC2H102J	CERAMIC	500V		1nF [△]
C358	ECUV1H222JCX	S.M. CAP	50V		2.2nF
C362	ECUV1H224ZFX	S.M. CAP	50V		220nF
C363	ECUV1H104KBX	S.M. CAP	50V		100nF
C364	ECQM2104KZ	FILM	250V		100nF
C365	ECKC2H102J	CERAMIC	500V		1nF [△]
C368	ECUV1H222JCX	S.M. CAP	50V		2.2nF
C369	ECUV1H220JCX	S.M. CAP	50V		22pF
C372	ECUV1H224ZFX	S.M. CAP	50V		220nF
C373	ECUV1H104KBX	S.M. CAP	50V		100nF
C374	ECQM2104KZ	FILM	250V		100nF
C375	ECKC2H102J	CERAMIC	500V		1nF [△]
C378	ECUV1H222JCX	S.M. CAP	50V		2.2nF
C381	ECA1HM101GB	ELECT	50V		100μF
C382	ECA1CM471GB	ELECT	16V		470μF
C383	ECUV1H103KBX	S.M. CAP	50V		10nF
C384	ECQM2104KZ	FILM	250V		100nF
C385	ECA2EM220B	ELECT	250V		22μF
C386	ECKC3D152J	CERAMIC	2KV		1.5nF [△]
C395	ECQM1H104J	FILM	50V		100nF
C396	ECJ2VF1H104Z	ELECT	350V		100nF
C451	ECUV1H102JX	S.M. CAP	50V		1nF
C453	ECUV1H152KBX	S.M. CAP	50V		1.5pF
C454	ECQV1H105JZ	FILM	50V		1μF
C455	ECA1HM100GB	ELECT	50V		10μF
C456	ECA1HHG221B	ELECT	50V		220μF
C459	ECQB1224KFW	FILM	100V		220nF
C463	ECEA1HU221	ELECT	50V		220μF
C508	ECQB1H103J	FILM	50V		10nF
C509	ECA1VM470B	ELECT	35V		47μF
C511	ECQM2683JZ	FILM	250V		68nF
C551	ECKC3D681J	CERAMIC	2KV		680pF [△]
C552	ECWH15H102JN	FILM	1500V		1nF
C557	ECKC2H471J	CERAMIC	500V		470pF [△]
C558	ECA1HHG471E	ELECT	50V		470μF
C561	ECA1EHG102B	ELECT	25V		1000μF
C562	ECKC2H101J	CERAMIC	500V		100pF [△]
C563	ECA2EHG220B	ELECT	250V		20μF
C564	ECEA2AU2R2	ELECT	100V		2.2μF
C565	ECQP1H273J	FILM	100V		2700μF

Cct Ref	Parts Number	Description			
C566	ECKC2H471J	CERAMIC	500V	470pF	△
C567	ECA1EHG102B	ELECT	25V	1000µF	
C568	ECKC2H471J	CERAMIC	500V	470pF	△
C569	ECKC2H102J	CERAMIC	500V	1 nF	△
C581	ECWF4684JBB	FILM	400V	680nF	
C582	ECWF4684JBB	FILM	400V	680nF	
C583	ECWH20562JVB	FILM	200V	5.6nF	
C584	ECWH20562JVB	FILM	200V	5.6nF	
C586	ECQF4123JZH	FILM	400V	12nF	△
C587	ECQM4223KC	FILM	400V	220nF	
C608	ECUV1H103KBX	S.M. CAP	50V	10nF	
C609	ECUV1H270JCX	S.M. CAP	50V	27pF	
C623	ECUV1H121JCX	S.M. CAP	50V	120pF	
C624	ECUV1H121JCX	S.M. CAP	50V	120pF	
C625	ECQM1H224J	FILM	50V	220nF	
C626	ECA1CM100GB	ELECT	16V	10µF	
C627	ECJ2VB1C104K	ELECT	350V	100nF	
C628	ECQM1H224J	FILM	50V	220nF	
C701	ECA1HHG101B	ELECT	50V	100µF	
C702	ECUV1H103KBX	S.M. CAP	50V	10nF	
C703	ECEA1HGE100	ELECT	50V	10µF	
C704	ECUV1H223KBX	S.M. CAP	50V	22nF	
C705	ECQB1H102J	FILM	50V	1 nF	
C709	ECQV1H105JZ	FILM	50V	1 µF	
C801	ECQE2A474MWB	FILM	250V	470nF	
C804	222233510224	FILM	250V	220nF	
C806	ECKWNA101MBC	CERAMIC	400V	100µF	
C807	ECKC2H472J	CERAMIC	500V	4.7nF	△
C808	ECKC2H472J	CERAMIC	500V	4.7nF	△
C809	ECKC2H472J	CERAMIC	500V	4.7nF	△
C810	ECKC2H472J	CERAMIC	500V	4.7nF	△
C811	ECOS2GA221CA	ELECT	400V	220µF	
C814	ECKC3D102J	CERAMIC	2KV	1 nF	△
C815	ECKC1H471J	CERAMIC	50V	470pF	
C816	ECA1EM101GB	ELECT	25V	100µF	
C817	ECQE6104K	FILM	600V	100nF	△
C818	ECKCNS332J	CERAMIC	1.2KV	3.3nF	△
C819	ECQB1H152K	FILM	50V	1.5nF	
C820	ECJ2VF1H104Z	ELECT	350V	100nF	
C839	ECA1CM100GB	ELECT	16V	10µF	
C840	ECJ2YB1H104K	ELECT	350V	100nF	
C841	ECA1AM222B	ELECT	10V	2200µF	
C842	ECA1CM100GB	ELECT	16V	10µF	
C850	ECKC3D471JB	CERAMIC	2KV	470pF	△
C851	ECA2CHG221E	ELECT	160V	220µF	
C852	ECA2CHG101E	ELECT	160V	100µF	
C853	ECKC2H471J	CERAMIC	500V	470pF	△
C854	ECA1EM102GB	ELECT	25V	100µF	
C855	ECKC2H471J	CERAMIC	500V	470pF	△
C856	ECA1AHG332B	ELECT	10V	3.3nF	
C857	ECKC2H471J	CERAMIC	500V	470pF	△
C858	ECEA1HGE102	ELECT	50V	1000µF	
C859	ECJ2VF1H104Z	ELECT	350V	100nF	
C860	ECA1HM101GB	ELECT	50V	100µF	
C862	ECJ2VF1H104Z	ELECT	350V	100nF	
C863	ECA1HM101GB	ELECT	50V	100µF	
C864	ECJ2VF1H104Z	ELECT	350V	100nF	
C865	ECA1CM100GB	ELECT	16V	10µF	
C866	ECJ2VF1H104Z	ELECT	350V	100nF	
C867	ECA1CM100GB	ELECT	16V	10µF	
C868	ECA1CM100GB	ELECT	16V	10µF	
C869	ECA1EM101GB	ELECT	25V	100µF	
C870	ECA1EM471GB	ELECT	25V	470µF	
C871	ECA1CM102B	ELECT	16V	1000µF	
C872	ECA1CM471GB	ELECT	16V	470µF	
C873	ECA1CM100GB	ELECT	16V	10µF	

Cct Ref	Parts Number	Description			
C875	ECA2CM4R7B	ELECT	160V	10µF	
C876	ECA1HHG101B	ELECT	50V	100µF	
C902	ECA1VM101GB	ELECT	35V	100µF	
C904	ECJ2VF1H103Z	ELECT	350V	10nF	
C906	ECUV1H680JCX	S.M. CAP	50V	68pF	
C907	ECUV1H121JCX	S.M. CAP	50V	120pF	
C908	ECUV1H151JCX	S.M. CAP	50V	150pF	
C909	ECKC2H472J	CERAMIC	500V	4.7nF	△
C910	ECKC2H472J	CERAMIC	500V	4.7nF	△
C911	ECUV1H151JCX	S.M. CAP	50V	150pF	
C912	ECA2EM220B	ELECT	250V	22µF	
C913	ECA1HM101GB	ELECT	50V	100µF	
C914	ECA1HM101GB	ELECT	50V	100µF	
C916	ECA2EM220B	ELECT	250V	22µF	
C917	ECA1HM100GB	ELECT	50V	10µF	
C918	ECJ2VF1H103Z	ELECT	350V	10nF	
C919	ECCR2H270J	CERAMIC	500V	27pF	
C1071	ECUV1H331JCX	S.M. CAP	50V	330pF	
C1072	ECUV1H103KBX	S.M. CAP	50V	10nF	
C1073	ECA1HM101GB	ELECT	50V	100µF	
C1101	ECJ2VF1H104Z	ELECT	350V	100nF	
C1102	ECA0JM101G	ELECT	6.3V	100µF	
C1103	ECUV1H220JCX	S.M. CAP	50V	22pF	
C1104	ECUV1H220JCX	S.M. CAP	50V	22pF	
C1105	ECUV1H101JCX	S.M. CAP	50V	100pF	
C1108	ECJ2VB1H333K	ELECT	350V	33nF	
C1111	ECA1CM100GB	ELECT	16V	10µF	
C1112	ECUV1H103KBX	S.M. CAP	50V	10nF	
C1115	ECJ3VB1C474K	ELECT	3.5KV	470nF	
C1116	ECUV1H472KBX	S.M. CAP	50V	4.7nF	
C1117	ECJ2VF1H104Z	ELECT	350V	100nF	
C1118	ECUV1H103KBX	S.M. CAP	50V	10nF	
C1119	ECUV1H221JCX	S.M. CAP	50V	220pF	
C1120	ECJ2VF1H104Z	ELECT	350V	100nF	
C1121	ECUV1H221JCX	S.M. CAP	50V	220pF	
C1123	ECUV1H471JCX	S.M. CAP	50V	470pF	
C1124	ECUV1H221JCX	S.M. CAP	50V	220pF	
C1125	ECUV1H221JCX	S.M. CAP	50V	220pF	
C1126	ECUV1H221JCX	S.M. CAP	50V	220pF	
C1127	ECUV1H561JCX	S.M. CAP	50V	560pF	
C1129	ECUV1H270JCX	S.M. CAP	50V	27pF	
C1130	ECA1CM221GB	ELECT	16V	220µF	
C1501	ECUV1H271JCX	S.M. CAP	50V	270pF	
C1502	ECUV1H271JCX	S.M. CAP	50V	270pF	
C1503	ECUV1H271JCX	S.M. CAP	50V	270pF	
C1504	ECUV1H271JCX	S.M. CAP	50V	270pF	
C1505	ECUV1H271JCX	S.M. CAP	50V	270pF	
C1506	ECUV1H271JCX	S.M. CAP	50V	270pF	
C1507	ECUV1H271JCX	S.M. CAP	50V	270pF	
C1508	ECUV1H271JCX	S.M. CAP	50V	270pF	
C1509	ECQM1H684J	FILM	50V	680nF	
C1510	ECQM1H684J	FILM	50V	680nF	
C1511	ECQM1H684J	FILM	50V	680nF	
C1512	ECQM1H684J	FILM	50V	680nF	
C1513	ECUV1H102JCX	S.M. CAP	50V	1 nF	
C1514	ECEA1CKA100	ELECT	16V	10µF	
C1515	ECJ2VB1H103K	ELECT	350V	10nF	
C1516	ECEA1CKA101	ELECT	16V	100µF	
C1517	ECJ2YB1H473K	ELECT	350V	47nF	
C1518	ECEA1CKA100	ELECT	16V	10µF	
C1519	ECUV1H050CCX	S.M. CAP	50V	50pF	
C1520	ECUV1H050CCX	S.M. CAP	50V	50pF	
C1521	ECJ2VB1H103K	ELECT	350V	10nF	
C1522	ECEA1CKA100	ELECT	16V	10µF	
C1523	ECJ2VB1H103K	ELECT	350V	10nF	
C1524	ECEA1CKA100	ELECT	16V	10µF	

Cct Ref	Parts Number	Description			
C1525	ECJ2VB1H103K	ELECT	350V	10nF	
C1526	ECEA1CKA100	ELECT	16V	10µF	
C1527	ECJ2VB1C104K	ELECT	350V	100nF	
C1528	ECEA1CKA100	ELECT	16V	10µF	
C1529	ECJ2VB1C104K	ELECT	350V	100nF	
C1530	ECEA1CKA100	ELECT	16V	10µF	
C1531	ECJ2VB1C104K	ELECT	350V	100nF	
C1532	ECEA1CKA100	ELECT	16V	10µF	
C1540	ECUV1H222JCX	S.M. CAP	50V	2.2nF	
C1541	ECJ2VB1H333K	ELECT	350V	33nF	
C1542	ECJ2VB1H333K	ELECT	350V	33nF	
C1543	ECJ2VB1C224K	ELECT	350V	220nF	
C1544	ECJ2VB1H333K	ELECT	350V	33nF	
C1545	ECEA1CKA100	ELECT	16V	10µF	
C1546	ECEA1CKA100	ELECT	16V	10µF	
C1547	ECJ2VB1H103K	ELECT	350V	10nF	
C1548	ECJ2VB1H103K	ELECT	350V	10nF	
C1549	ECJ2VB1H103K	ELECT	350V	10nF	
C1550	ECJ2VB1H103K	ELECT	350V	10nF	
C1551	ECUV1H103KBX	S.M. CAP	50V	10nF	
C1552	ECUV1H103KBX	S.M. CAP	50V	10nF	
C1553	ECEA1CKA100	ELECT	16V	10µF	
C1554	ECJ2VB1H103K	ELECT	350V	10nF	
C1555	ECJ2VB1C104K	ELECT	350V	100nF	
C1556	ECUV1H270JCX	S.M. CAP	50V	27pF	
C1557	ECUV1H270JCX	S.M. CAP	50V	27pF	
C1558	ECJ2VB1H103K	ELECT	350V	10nF	
C1559	ECEA1CKA100	ELECT	16V	10µF	
C1560	ECEA1CKA100	ELECT	16V	10µF	
C1561	ECJ2VB1C104K	ELECT	350V	100nF	
C1562	ECJ2VB1C104K	ELECT	350V	100nF	
C1563	ECJ2VB1C104K	ELECT	350V	100nF	
C1564	ECJ2VB1C104K	ELECT	350V	100nF	
C1566	ECUV1H270JCX	S.M. CAP	50V	27pF	
C1567	ECEA1CKA100	ELECT	16V	10µF	
C1568	ECJ2VB1H103K	ELECT	350V	10nF	
C1569	ECEA1CKA100	ELECT	16V	10µF	
C1570	ECJ2VB1H103K	ELECT	350V	10nF	
C1571	ECJ2VB1H103K	ELECT	350V	10nF	
C1572	ECEA1CKA100	ELECT	16V	10µF	
C1573	ECJ2VB1H103K	ELECT	350V	10nF	
C1574	ECEA1CKA100	ELECT	16V	10µF	
C1575	ECEA1CKA100	ELECT	16V	10µF	
C1576	ECJ2VB1H103K	ELECT	350V	10nF	
C1577	ECUV1H270JCX	S.M. CAP	50V	27pF	
C1578	ECJ2VB1H103K	ELECT	350V	10nF	
C1579	ECJ2VB1H103K	ELECT	350V	10nF	
C1580	ECJ2VB1H103K	ELECT	350V	10nF	
C1581	ECJ2VB1C224K	ELECT	350V	220nF	
C1582	ECJ2VB1C224K	ELECT	350V	220nF	
C1583	ECJ2VB1C224K	ELECT	350V	220nF	
C1584	ECJ2VB1C104K	ELECT	350V	100nF	
C1585	ECEA1CKA100	ELECT	16V	10µF	
C1586	ECJ2VB1H103K	ELECT	350V	10nF	
C1587	ECEA1CKA100	ELECT	16V	10µF	
C1588	ECEA1CKA100	ELECT	16V	10µF	
C1589	ECJ2VB1H103K	ELECT	350V	10nF	
C1590	ECJ2VB1H103K	ELECT	350V	10nF	
C1591	ECEA1CKA100	ELECT	16V	10µF	
C1592	ECUV1H271JCX	S.M. CAP	50V	270pF	
C1594	ECUV1H271JCX	S.M. CAP	50V	270pF	
C1596	ECUV1H271JCX	S.M. CAP	50V	270pF	
C1598	ECUV1H330JCX	S.M. CAP	50V	33pF	
C1603	ECKC1H271J	CERAMIC	50V	270pF	
C2101	ECUV1H102JCX	S.M. CAP	50V	1nF	
C2102	ECUV1H102JCX	S.M. CAP	50V	1nF	

Cct Ref	Parts Number	Description			
C2103	ECUV1H102JCX	S.M. CAP	50V	1nF	
C2104	ECUV1H102JCX	S.M. CAP	50V	1nF	
C2105	ECUV1H102JCX	S.M. CAP	50V	1nF	
C2106	ECUV1H102JCX	S.M. CAP	50V	1nF	
C2107	ECUV1H102JCX	S.M. CAP	50V	1nF	
C2108	ECUV1H102JCX	S.M. CAP	50V	1nF	
C2109	ECUV1H102JCX	S.M. CAP	50V	1nF	
C2110	ECUV1H102JCX	S.M. CAP	50V	1nF	
C2111	ECA1CM100GB	ELECT	16V	10µF	
C2112	ECA1CM100GB	ELECT	16V	10µF	
C2113	ECA1HM3R3GB	ELECT	50V	3.3µF	
C2114	ECJ2VF1H104Z	ELECT	350V	100nF	
C2115	ECUV1H221JCX	S.M. CAP	50V	220pF	
C2116	ECUV1H221JCX	S.M. CAP	50V	220pF	
C2117	ECUV1H221JCX	S.M. CAP	50V	220pF	
C2118	ECUV1H221JCX	S.M. CAP	50V	220pF	
C2119	ECUV1H221JCX	S.M. CAP	50V	220pF	
C2120	ECUV1H221JCX	S.M. CAP	50V	220pF	
C2121	ECA1CM100GB	ELECT	16V	10µF	
C2122	ECJ2VF1H104Z	ELECT	350V	100nF	
C2123	ECUV1H221JCX	S.M. CAP	50V	220pF	
C2124	ECUV1H070DTX	S.M. CAP	50V	70pF	
C2125	ECUV1H470JCX	S.M. CAP	50V	47pF	
C2126	ECUV1H560JCX	S.M. CAP	50V	56pF	
C2127	ECUV1H010CCX	S.M. CAP	50V	1pF	
C2128	ECUV1H010CCX	S.M. CAP	50V	1pF	
C2129	ECA1CM102B	ELECT	16V	1000µF	
C2130	ECA1CM331B	ELECT	16V	330µF	
C2134	ECUV1H103ZFX	S.M. CAP	50V	10nF	
C2135	ECA1HM101GB	ELECT	50V	100µF	
C2136	ECJ2VF1H104Z	ELECT	350V	100nF	
C2137	ECA1CM100GB	ELECT	16V	10µF	
C2138	ECUV1H471KBX	S.M. CAP	50V	470pF	
C2139	ECUV1H221JCX	S.M. CAP	50V	220pF	
C2140	ECA1HM101GB	ELECT	50V	100µF	
C2141	ECUV1H152JCX	S.M. CAP	50V	1.5pF	
C2301	ECUV1H222JCX	S.M. CAP	50V	2.2nF	
C2302	ECA1CM470GB	ELECT	16V	47µF	
C2303	ECUV1H222JCX	S.M. CAP	50V	2.2nF	
C2304	ECA1CM470GB	ELECT	16V	47µF	
C3001	ECUV1H222JCX	S.M. CAP	50V	2.2nF	
C3002	ECUV1H222JCX	S.M. CAP	50V	2.2nF	
C3003	ECA1CM470GB	ELECT	16V	47µF	
C3005	ECUV1H561JCX	S.M. CAP	50V	560pF	
C3006	ECJ3VB1C474K	ELECT	3.5KV	470nF	
C3007	ECUV1H222JCX	S.M. CAP	50V	2.2nF	
C3008	ECUV1H222JCX	S.M. CAP	50V	2.2nF	
C3009	ECUV1H222JCX	S.M. CAP	50V	2.2nF	
C3010	ECA1CM470GB	ELECT	16V	47µF	
C3012	ECUV1H561JCX	S.M. CAP	50V	560pF	
C3013	ECJ3VB1C474K	ELECT	3.5KV	470nF	
C3014	ECUV1H222JCX	S.M. CAP	50V	2.2nF	
C3015	ECUV1H222JCX	S.M. CAP	50V	2.2nF	
C3016	ECUV1H222JCX	S.M. CAP	50V	2.2nF	
C3017	ECA1CM470GB	ELECT	16V	47µF	
C3019	ECUV1H561JCX	S.M. CAP	50V	560pF	
C3020	ECJ3VB1C474K	ELECT	3.5KV	470nF	
C3021	ECUV1H222JCX	S.M. CAP	50V	2.2nF	
C3022	ECUV1H222JCX	S.M. CAP	50V	2.2nF	
C3023	ECUV1H222JCX	S.M. CAP	50V	2.2nF	
C3024	ECA1CM470GB	ELECT	16V	47µF	
C3026	ECUV1H561JCX	S.M. CAP	50V	560pF	
C3027	ECJ3VB1C474K	ELECT	3.5KV	470nF	
C3028	ECUV1H222JCX	S.M. CAP	50V	2.2nF	
C3030	ECUV1H271JCX	S.M. CAP	50V	270pF	
C3031	ECUV1H271JCX	S.M. CAP	50V	270pF	

Cct Ref	Parts Number	Description		
C3032	ECUV1H271JCX	S.M. CAP	50V	270pF
C3101	ECUV1H104KBX	S.M. CAP	50V	100nF
C3102	ECUV1E104KBX	S.M. CAP	25V	100nF
C3103	ECUV1H561JCX	S.M. CAP	50V	560pF
C3104	ECUV1H561JCX	S.M. CAP	50V	560pF
C3105	ECUV1H561JCX	S.M. CAP	50V	560pF
C3106	ECUV1H561JCX	S.M. CAP	50V	560pF
C3107	ECA1HM470GB	ELECT	50V	47µF
C3108	ECA1HM470GB	ELECT	50V	47µF
C3111	ECUV1H222KBX	S.M. CAP	50V	2.2nF
C3351	ECA1CM221GB	ELECT	16V	220µF
TERMINALS AND LINKS				
JK2301	JPJ841101320	RCA SOCKET		
JK3001	0350808500	SCART SOCKET		
JK3101	TJB16673	A.V. TERMINAL		
SWITCHES				
S801	ESB92S11B	SWITCH		△
S1201	EVQ21405R	SWITCH		
S1202	EVQ21405R	SWITCH		
S1203	EVQ21405R	SWITCH		
S1204	EVQ21405R	SWITCH		
S1205	EVQ21405R	SWITCH		
DIFFERENCES FOR MODEL TX-25LD20F				
MECHANICAL PARTS				
20	TKU8E00310	BACK COVER		△
21	A59ECF50X82	C.R.T.		△
22	TKY8E216	CABINET		△
23	TLK8E05138	DEGAUSS COIL		△
24	TNP8EE013AB	E P.C.B.		△
25	TQF8E2903	MODEL LABEL		△
MISCELLANEOUS COMPONENTS				
	TPC8E4660-1	OUTER CARTON		
	TPD8E657	TOP CUSHION		
	TPD8E658	BOTTOM CUSHION		
I.C.s				
IC1103	XDG3-05LF	EAROM *		
DIFFERENCES FOR MODEL TX-28LD20F				
MECHANICAL PARTS				
20	TKU8E00320	BACK COVER		△
21	A66ECF50X82	C.R.T.		△
22	TKY8E309	CABINET		△
23	TLK8E05140	DEGAUSS COIL		△
24	TNP8EE013AA	E P.C.B.		△
25	TQF8E2872	MODEL LABEL		△
MISCELLANEOUS COMPONENTS				
	TPC8E4659	OUTER CARTON		
	TPD8E655	TOP CUSHION		
	TPD8E656	BOTTOM CUSHION		
I.C.s				
IC1103	XDG3-05KF	EAROM *		

Cct Ref	Parts Number	Description
---------	--------------	-------------

SCHEMATIC DIAGRAMS FOR MODELS
TX-28LD20F
TX-25LD20F
(EURO-4H CHASSIS)

ZEICHENERKLÄRUNG FÜR MODELL
TX-28LD20F
TX-25LD20F
(EURO-4H CHASSIS)





IMPORTANT SAFETY NOTICE

Components identified by  mark have special characteristics important for safety. When replacing any of these components, use only manufacturer's specified parts.

WICHTIGER SICHERHEITSHINWEIS

Teile, die mit einem Hinweis  gekennzeichnet sind, sind wichtig für die Sicherheit, Sollte ein Auswechsein erforderlich sein, sind unbedingt Originalteile einzusetzen.

NOTES





1. RESISTOR
All resistors are carbon 1/4W resistor, unless marked otherwise.
Unit of resistance is OHM (Ω) (k=1,000, M=1,000,000)
2. CAPACITORS
All capacitors are ceramic 50V unless marked otherwise.
Unit of capacitance is μ F unless otherwise stated.
3. COIL
Unit of inductance is μ H, unless otherwise stated.
4. Components marked "L" on the schematic diagram shows leadless parts.
5. TEST POINT
 Test Point Position
6. EARTH SYMBOL
 Chassis Earth (Cold)  Line Earth (Hot)
7. VOLTAGE MEASUREMENT
Voltage is measured by a d.c. voltmeter.
Measurement conditions are as follows:
Power source a.c. 220V-240V, 50Hz
Receiving Signal Colour Bar signal (RF)
All customer controls Maximum position
8.  Indicates the Video signal path
 Indicates the Audio signal path

These schematic diagrams are the latest at time of printing and are subject to change without notice.

REMARKS

1. The Power Supply Circuit contains a circuit area which uses a separate power supply to isolate the earth connection. The circuit is defined by HOT and COLD indications in the schematic diagram. All circuits except the Power Circuit, are COLD. Take the following precautions :-
 - a. Do not touch the hot part, or the hot and cold parts at the same time, as you are liable to a shock hazard.
 - b. Do not short circuit the hot and cold circuits as electrical components may be damaged.
 - c. Do not connect an instrument, such as an oscilloscope, to the hot and cold circuits simultaneously as this may cause fuse failure. Connect the earth of the instruments to the earth connection of the circuit being measured.
 - d. Make sure to disconnect the power plug before removing the chassis.

ANMERKUNG

1. WIDERSTÄNDE
Alle 1/4W Widerstände sind Kohlewiderstände, Abweichungen sind folgt gekennzeichnet.
Die Maßeinheit ist OHM (Ω) (k=1,000, M=1,000,000)
2. KONDENSATOREN
Alle Kondensatoren sind Keramikausführungen. Spannungsfestigkeit 50V. Abweichungen sind wie folgt gekennzeichnet. Die Maßeinheit ist μ F, wenn keine anderen Bezeichnungen genannt sind.
3. SPULEN
Die Maßeinheit ist μ H, Abweichungen sind gekennzeichnet.
4. Mit "L" gekennzeichnete Teile sind ohne Anschlußdrähte.
5. TESTPUNKTE
 Kennzeichnung der Testpunktposition
6. MASSE SYMBOL
 Erdung am Chassis  Erdung an Masse-Leitung
7. SPANNUNGSMESSUNG
Spannungsmessungen sind mit einem d.c.-Voltmeter durchzuführen. Die Meßbedingungen sind folgende:
Netzspannung a.c. 220V-240V, 50Hz
Wiedergabe Signal Farbbalken-Testbild
Wiedergabesignal Farbbalken-Testbild (HF)
8.  Videosignalweg
 Audiosignalweg

Änderungen im Laufe der Fertigung sind möglich.

BEMERKUNGEN

1. Das Schaltnetzteil enthält Bereiche, die direkt mit dem Netz verbunden sind. Diese Bereiche sind im Schaltplan mit HOT gekennzeichnet. Alle anderen Schaltungen sind mit COLD gekennzeichnet und haben keine direkte Verbindung mit dem Netz :-
 - a. Weder die Leitungen im heißen noch Leitungen im heißen und im kalten Bereich gleichzeitig berühren. Es besteht die Gefahr eines elektrischen Schlages.
 - b. Keinesfalls die Leitungen im heißen Bereich mit denen im kalten Bereich verbinden oder kurzschliessen. Dies kann zur Zerstörung von Bauteilen oder Sicherungen führen. Außerdem ist die elektrische Betriebssicherheit des Gerätes nicht mehr gegeben.
 - c. Keine Messinstrumente gleichzeitig an Leitungen im heißen und kalten Bereich anschliessen. Sicherungen könnten zerstört werden. Die Erde des Messinstrumentes immer mit der des zu prüfenden Schaltkreises verbinden.
 - d. Vor Ausbau des Chassis, Stecker aus der Netzsteckdose ziehen.

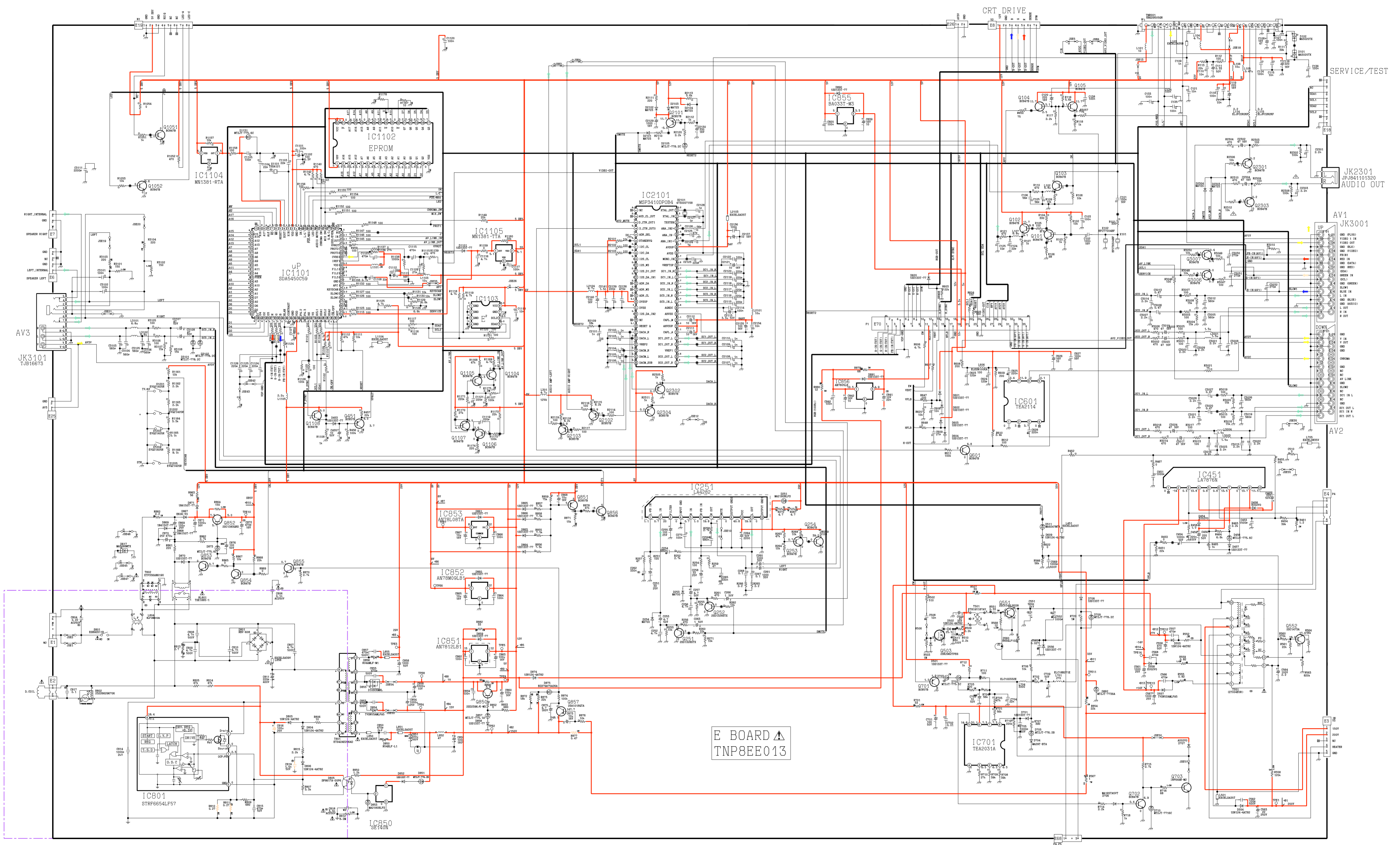

E BOARD
TNP8EE013

SERVICE/TEST

JK2301
JPJ841101320
AUDIO OUT

AV1
JK3001

AV2

E4

E3
150V
50V
NC
HEATER
GND

JK3101
TUB16673

AV3

AV3

SERVICE/TEST

E1

E2
150V
50V
NC
HEATER
GND

E3
150V
50V
NC
HEATER
GND

F BOARD
TNP8EF007

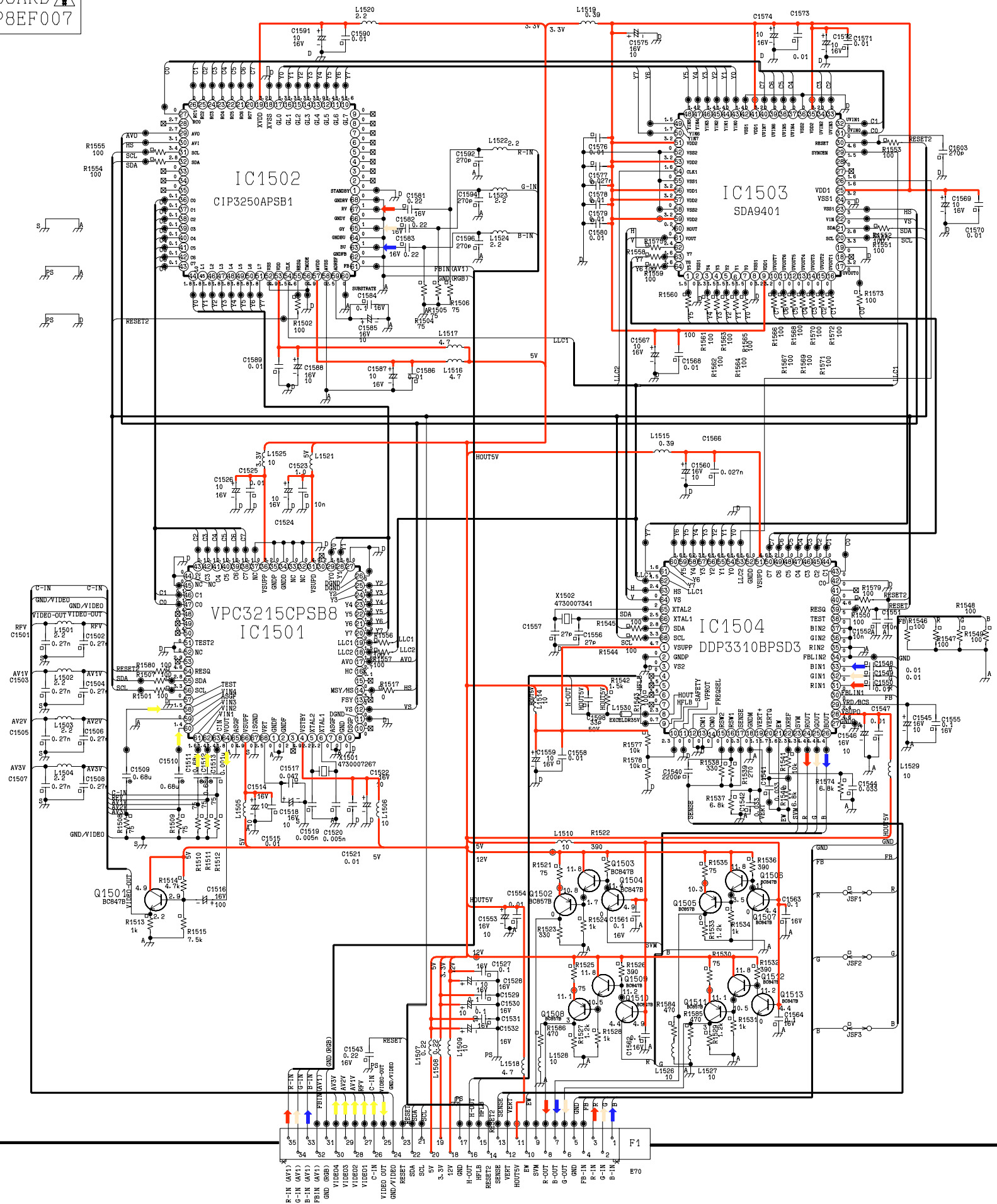

R-IN (AV1)
G-IN (AV1)
B-IN (AV1)
FBN (AV1)
GND (R8B)
VIDEO3
VIDEO2
VIDEO1
C-IN
VIDEO OUT
GND/VIDEO
RESET
SCL
SDA
5V
3.3V
12V
HOUT
HOUT5V
SENSE
VREF
HOUT5V
SW
R-OUT
B-OUT
G-OUT
FB-IN
R-IN
G-IN
B-IN
E70

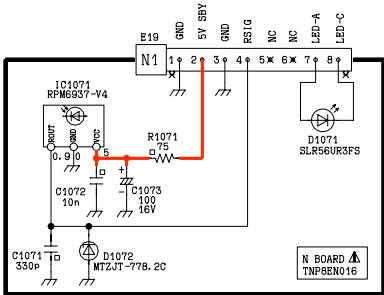

P BOARD ⚠
TNP8EP017

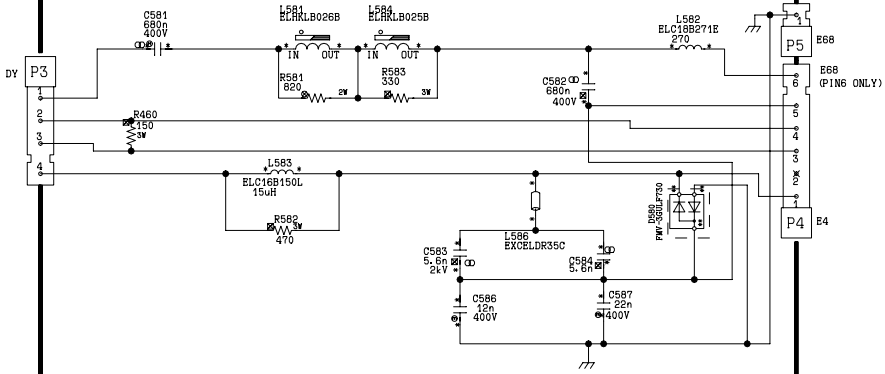

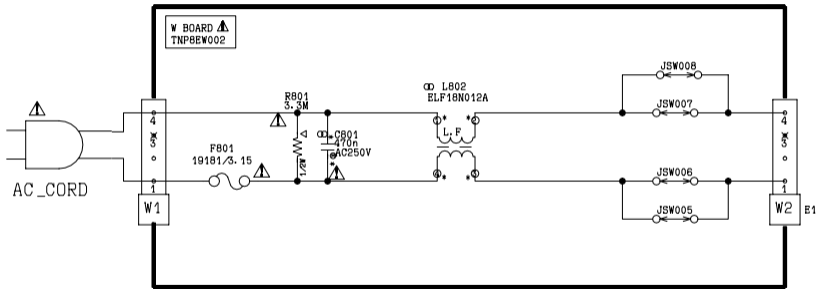

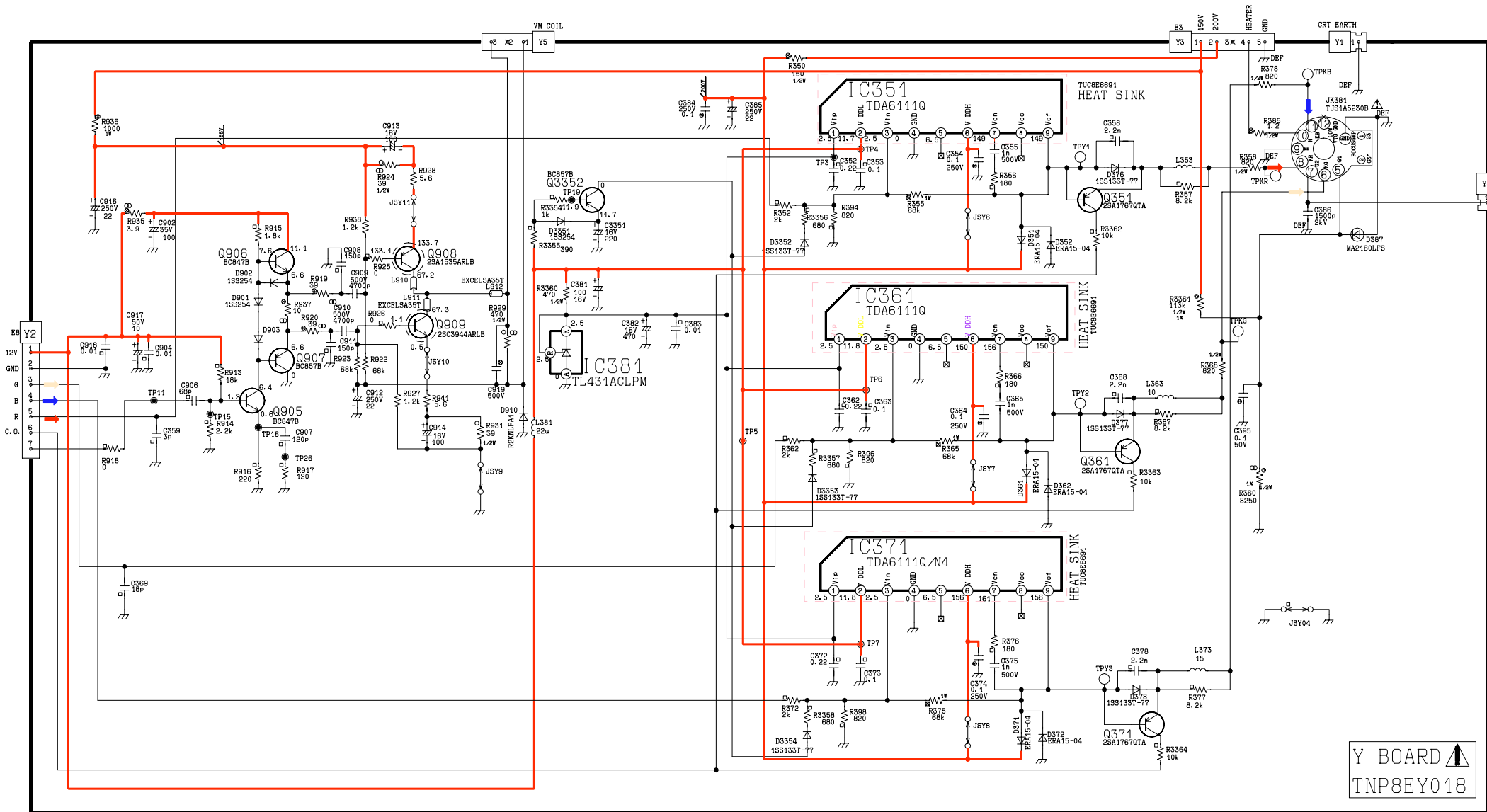

E-BOARD TNP8EE013

TRAN'S		DIODES			
Q101	H10	D251	D4	D869	B4
Q103	F10	D253	C4	D870	C4
Q104	N9	D254	B5	D871	A5
Q105	M8	D453	F9	D873	B5
Q182	G10	D454	L5	D875	J5
Q251	D4	D456	L5	D890	L7
Q252	C4	D457	L5	D891	K7
Q253	C4	D458	L5	D1051	A9
Q254	C5	D501	I3	D1101	G7
Q451	F8	D502	J2	D1103	F8
Q503	I2	D511	M5	D1104	A4
Q551	K1	D553	K4	D1105	A3
Q552	N3	D554	M3	D1116	G7
Q601	K9	D555	N3	D2101	G9
Q701	K8	D556	K1	D2102	G9
Q702	J5	D557	M4	D2103	G10
Q703	K4	D558	L4	D2104	G9
Q850	F5	D559	J1	D2105	G9
Q851	F9	D560	K2	D2303	G7
Q852	B5	D601	K8	D2304	G7
Q853	B4	D602	K8	D3101	B7
Q854	B4	D603	K8	D3102	B7
Q855	J5	D604	K8		
Q856	F9	D609	M5		
Q857	J4	D620	J9	TPE1	M4
Q1051	C8	D701	K5	TPE10	B5
Q1052	A9	D702	K8	TPE11	N5
Q1101	F7	D703	K8	TPE12	K4
Q1104	D6	D704	K5	TPE13	M4
Q1105	C6	D705	K5	TPE14	L4
Q1106	D7	D706	K5	TPE2	I5
Q1107	C7	D707	J4	TPE3	E5
Q1108	F9	D708	M5	TPE4	G5
Q2101	G10	D709	M5	TPE5	G5
Q2102	I8	D710	J5	TPE6	J10
Q2103	I8	D801	E1	TPE7	I9
Q2301	M6	D802	G2	TPE8	F5
Q2302	I7	D803	H1	TPE9	F5
Q2303	M6	D804	H1		
Q2304	I7	D805	H2		
Q3006	N10	D806	G2	IC251	D6
Q3007	M9	D850	H4	IC451	L5
		D851	I4	IC601	K9
		D852	I4	IC701	K5
		D853	H3	IC801	G2
		D854	G4	IC850	H4
		D856	F4	IC851	G5
		D857	E5	IC852	I10
		D858	E5	IC853	I9
		D859	H5	IC855	L7
		D860	I10	IC856	J7
		D861	J9	IC1051	A10
		D862	N10	IC1101	D8
		D863	G9	IC1102	D10
		D864	I9	IC1103	F8
		D865	I9	IC1104	C9
		D866	I9	IC1105	F7
		D867	A3	IC2101	H8
		D868	B4		

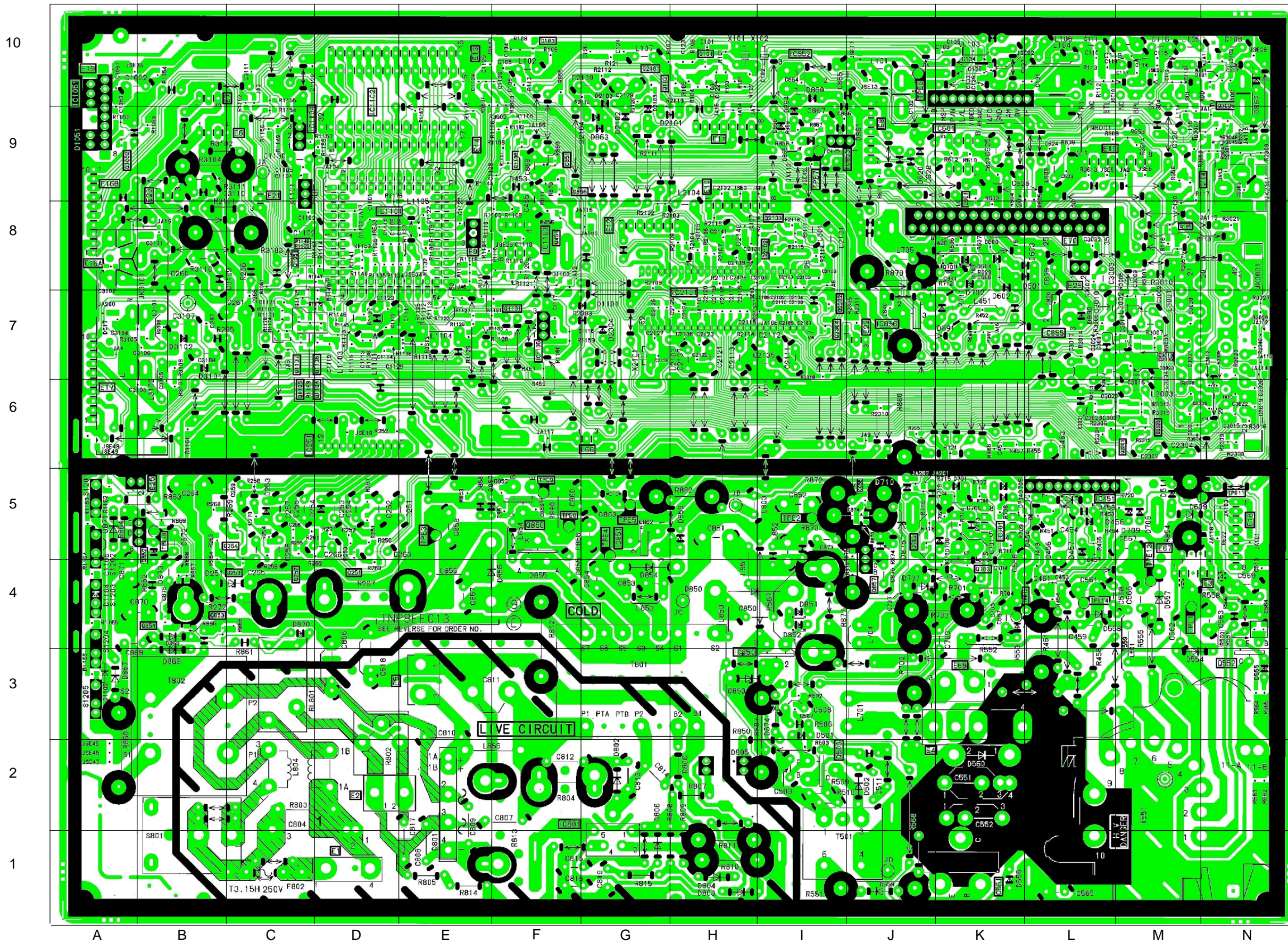

Y - BOARD TNP8EY018

TRAN'S	
Q351	B3
Q361	B2
Q371	C2
Q905	B1
Q906	C1
Q907	B1
Q908	D1
Q909	D1
Q3351	A2
Q3352	A2
DIODES	
D351	B3
D352	B3
D361	B2
D362	A1
D371	D2
D372	C2
D373	C3
D374	A1
D375	B2
D376	B3
D377	A2
D378	C2
D387	B1
D901	C1
D902	C1
D903	C1
D910	C1
D911	D2
D912	D1
D3351	A2
D3352	A3
D3353	A1
D3354	C3
T.P.'S	
TPY1	B3
TPY2	A2
TPY3	C2
TPKR	B3
TPKG	B2
TPKB	C2
I.C.'S	
IC351	B2
IC361	A1
IC371	C3
IC381	C3

A

B

C

D

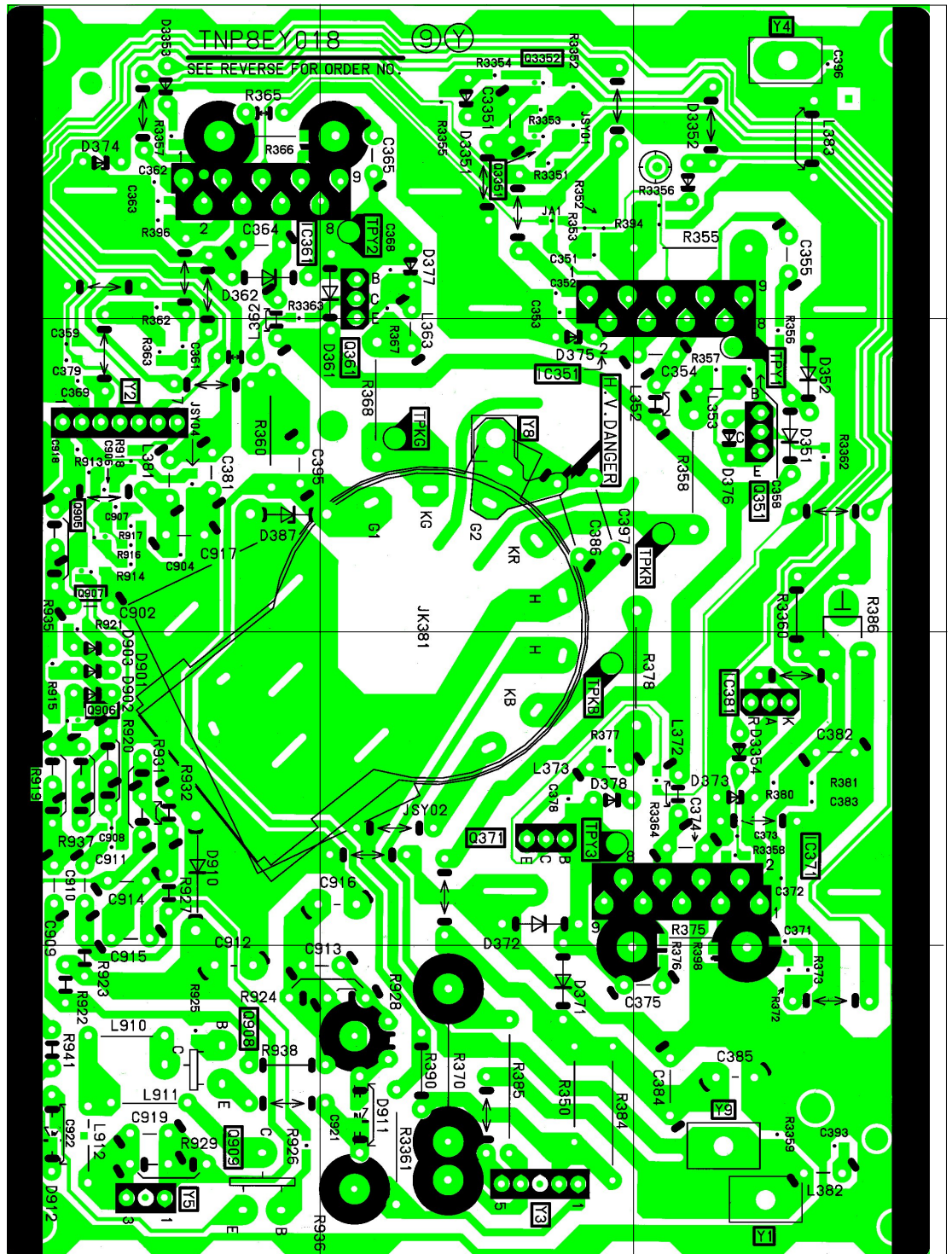

1

2

3

N - BOARD TNP8EN016

DIODES	
D1072	A6
D1071	B3
IC'S	
IC1071	B2

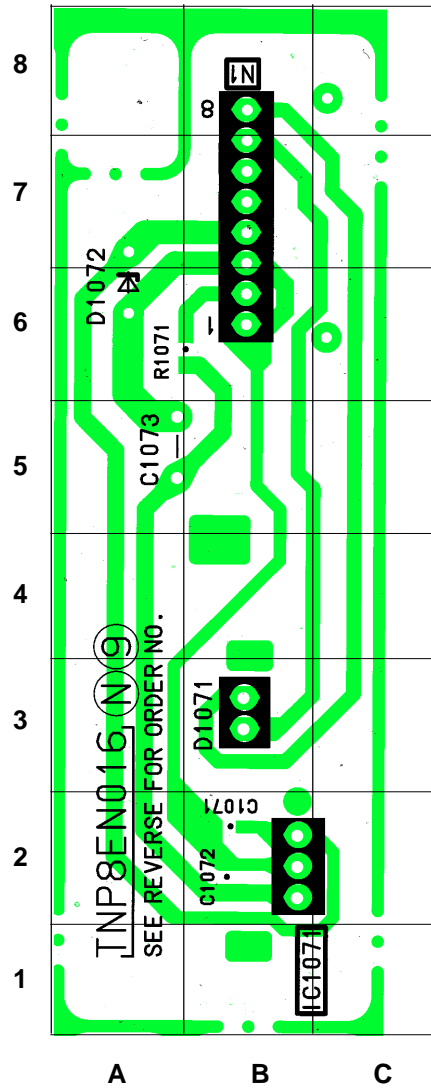

P - BOARD TNP8EP017

DIODES	
D580	C1
D581	C1

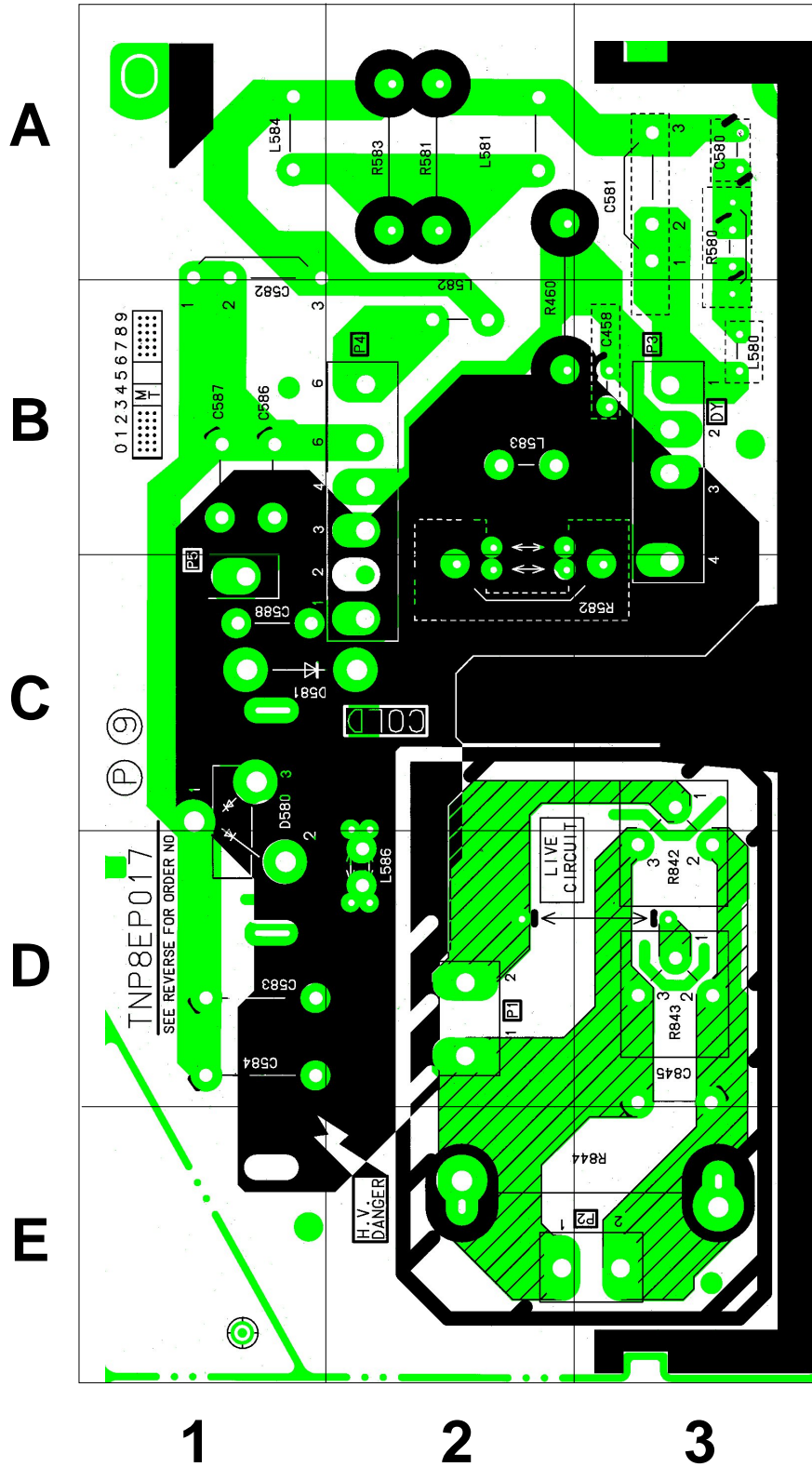

W - BOARD TNP8EW002

I.C.'S
IC1901 A2

